

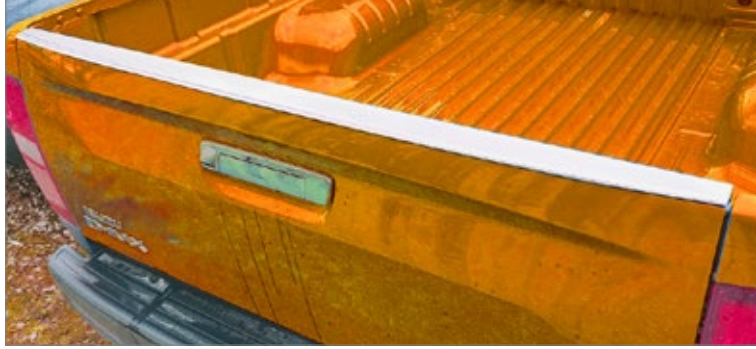

# Isuzu D-Max 2021-

Art. 813210

Tagaluugi servakaitse | Protector, edge of failgate | Защита краю задней двери | Schutz für die Kante der Heckklappe



- |  |   |
|--|---|
| 1. Kaitseplekk / skip plate / защитная пластина / skip platte          | 1 |
| 2. Puks / bushing / бужка / Buchse                                     | 6 |
| 3. Seib / flat washer / шайба / Scheibe 5,3x10x1                       | 6 |
| 4. Plekikruvi / dill screw / самонарезающий винт / Bohrschraube 4,8x19 | 6 |

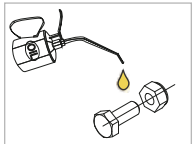
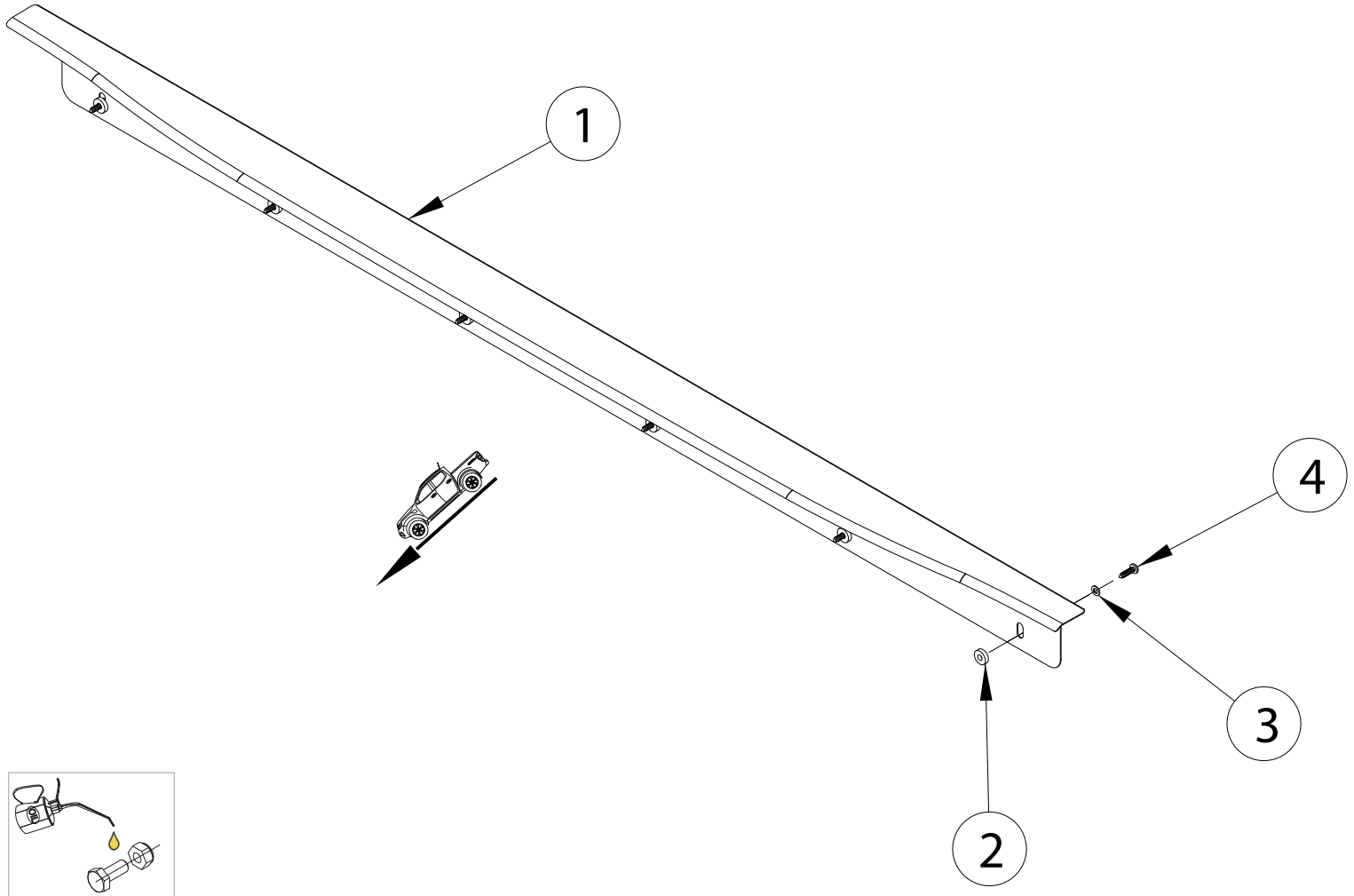

Kaal / Weight / Масса / Gewicht: 1,7 kg

Paigaldusaeg ilma elektritöödeta / Time of mounting w/o wiring works / Время установки без электромонт. работ / Einbauzeit ohne elektrische arbeit: 15 min

Vajalikud tööriistad / Required Tools / Необходимые инструменты / Benötigte Werkzeuge



# Isuzu D-Max 2021-

Tagaluugi servakaitse | Protector, edge of failgate | Защита краю задней двери | Schutz für die Kante der Heckklappe

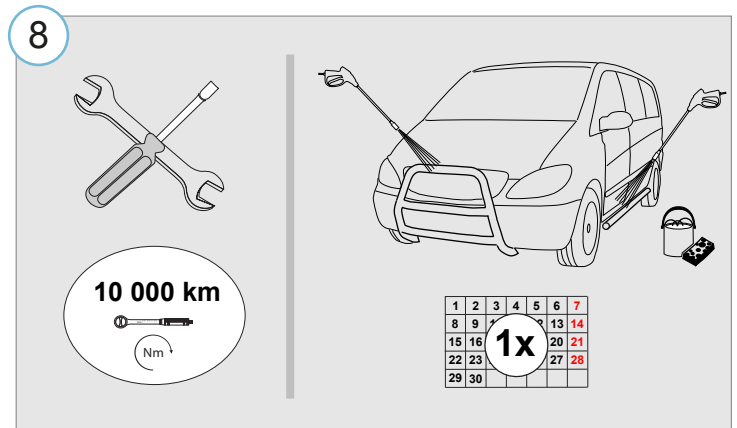
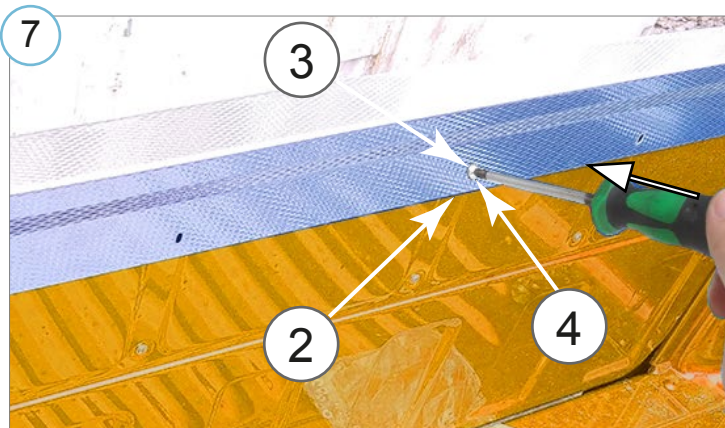
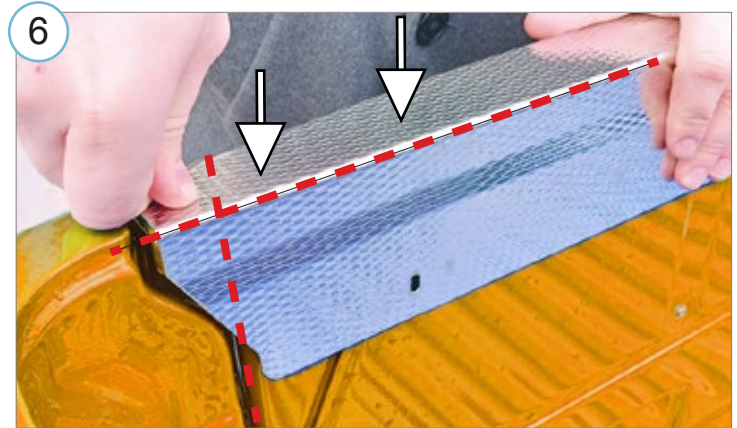
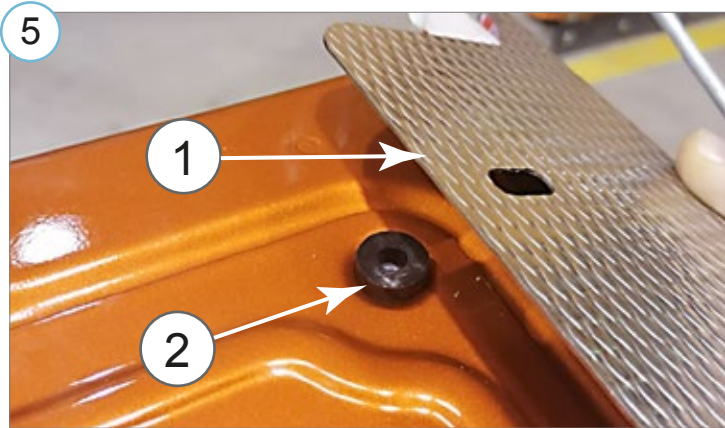
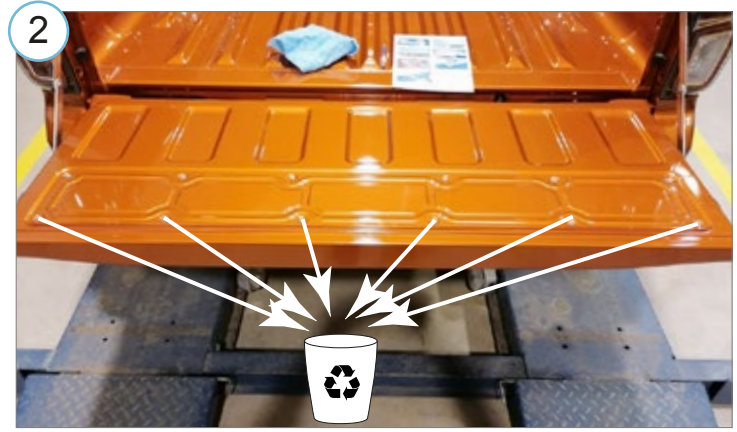
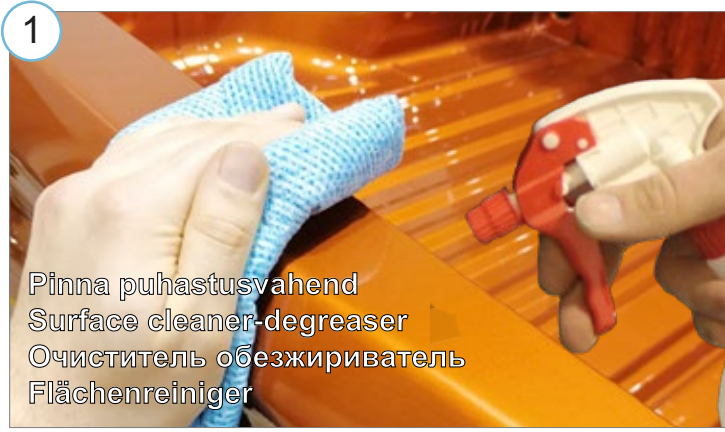

- Kui METEC toode ei vasta Teie ootustele või kui on tegemist toote ebapiisava kvaliteediga, siis pretensioonid esitada lehel [www.metec.ee](http://www.metec.ee)
- If the METEC product does not meet Your expectations or if it is a product of insufficient quality, then you can submit a claim at [www.metec.ee](http://www.metec.ee)
- Если METEC продукт не соответствует Вашим ожиданиям или это продукт недостаточного качества, то претензию предъявить можно на сайте [www.metec.ee](http://www.metec.ee)
- Wenn METEC Produkt nicht Ihren Erwartungen entspricht oder wenn es um Qualitätsmängel geht, dann bitte die Ansprüche auf Seite [www.metec.ee](http://www.metec.ee) einreichen