

**Anbauanleitung:** Seilwindenanbausatz

**AL:** 2182-00

**Best.Nr.:** 16-3170

**Montagezeit:** ca. 300 min.

***Hier sehen sie den fertig montierten Seilwindenanbausatz.  
Bevor sie mit der Montage beginnen, lesen sie bitte diese Anleitung und das  
Benutzerhandbuch der Seilwinde gut durch.***

***Before you start fitting, please read and understand this instruction manual and the owners  
manual of the winch.***



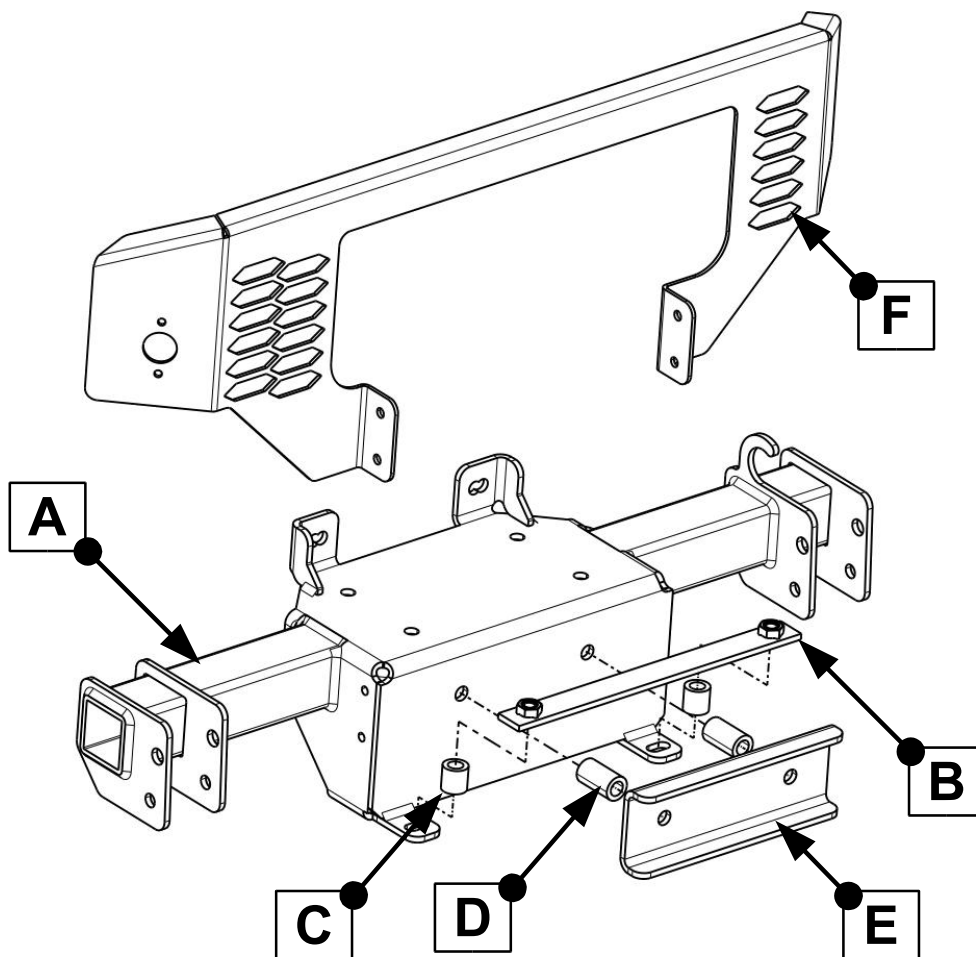

## Stückliste

\*\*\*16-317\*\*\*

## Schraubensatz

1x Windenplatte (A)  
 1x Gewindeleiste (B)  
 2x Distanzhülse kurz (C)  
 2x Distanzhülse lang (D)  
 1x Gegenplatte (E)  
 1x Blende (F)

1x Anbauanleitung  
 1x Gutachten+Aufkleber

4x Schraube M10 x 75  
 2x Schraube M10 x 50  
 10x Scheibe M10  
 4x Scheibe M10 x 30 x 3  
 6x Federring M10  
 4x Mutter M10

2x Schraube M8 x 75  
 2x Senkkopfschraube M8 x 30  
 2x Scheibe M8 x 20 x 1,25  
 4x Scheibe M8  
 4x Federring M8  
 4x Mutter M8

4x Schraube M6 x 25  
 4x Scheibe M6  
 4x Federring M6  
 4x Mutter M6

**Schrauben Anzugsmomente siehe letzte Seite!**  
*For torque information please see last page!*



1

**Kühlergrill demontieren! / Remove the radiator grill!**



2

**Rahmen entfernen! / Remove the frame!**



**3**

**Stoßfänger entfernen! / Remove the bumper!**



**4**

**Luftkanal entfernen! / Remove the air duct!**

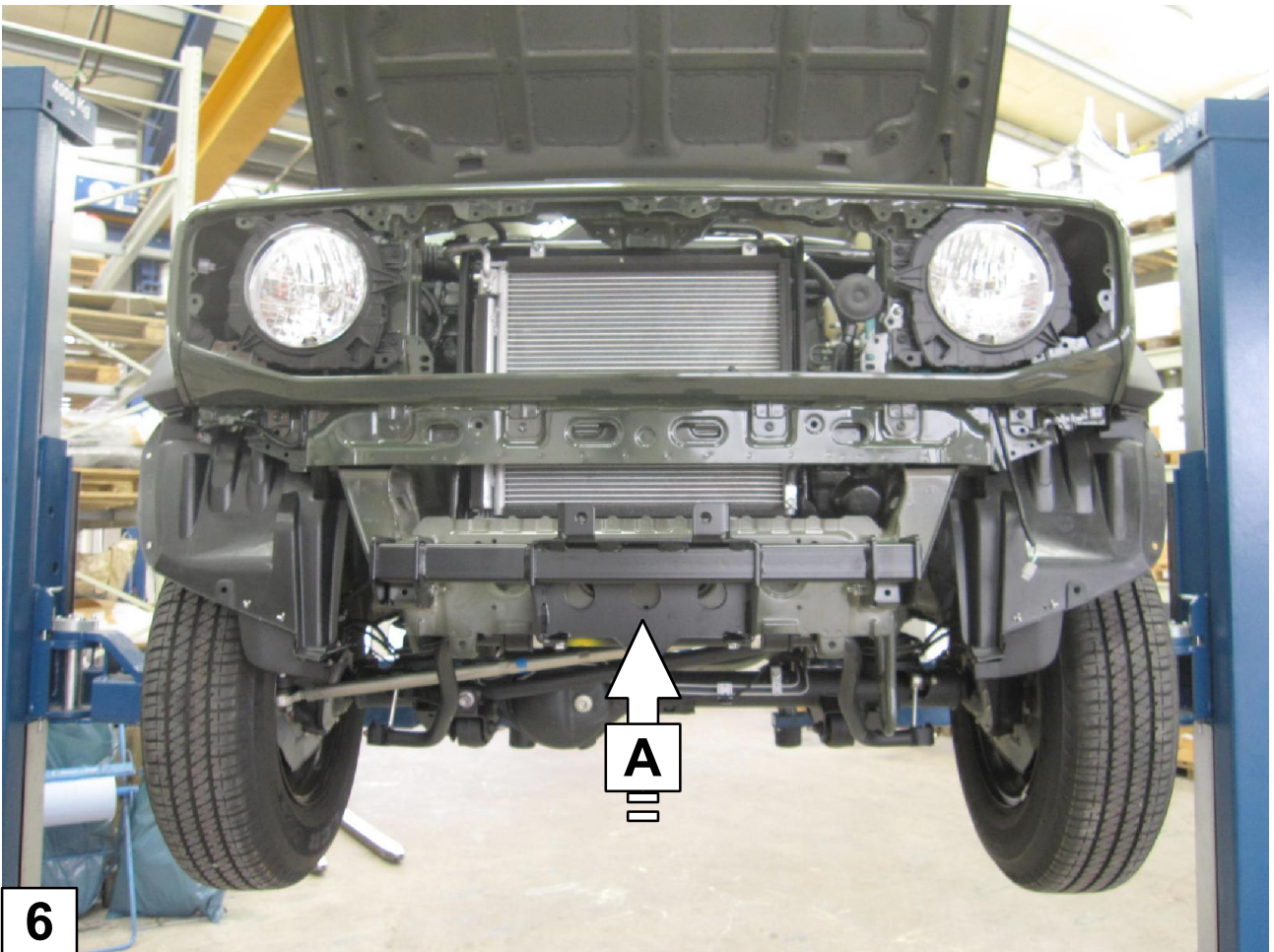
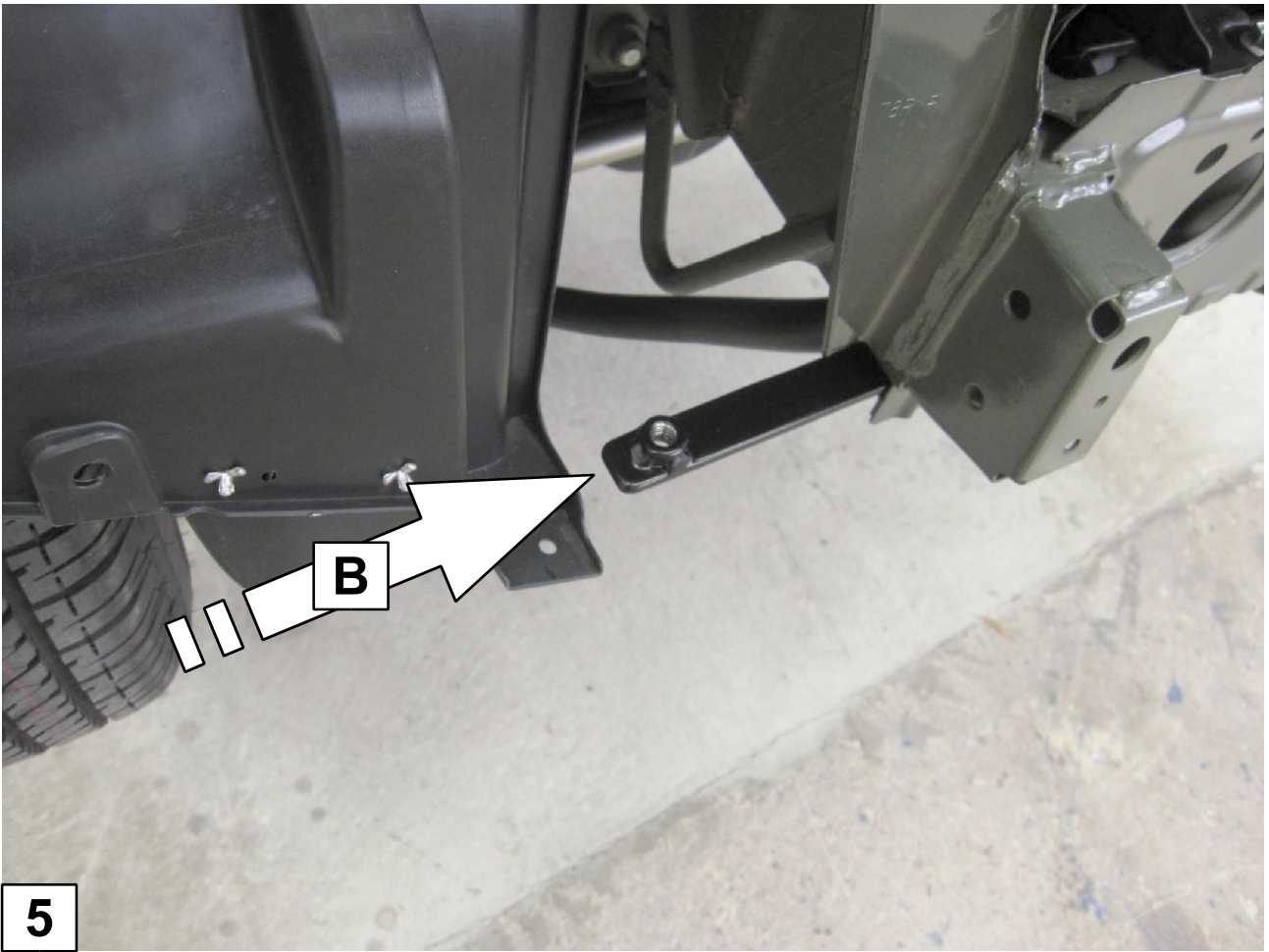

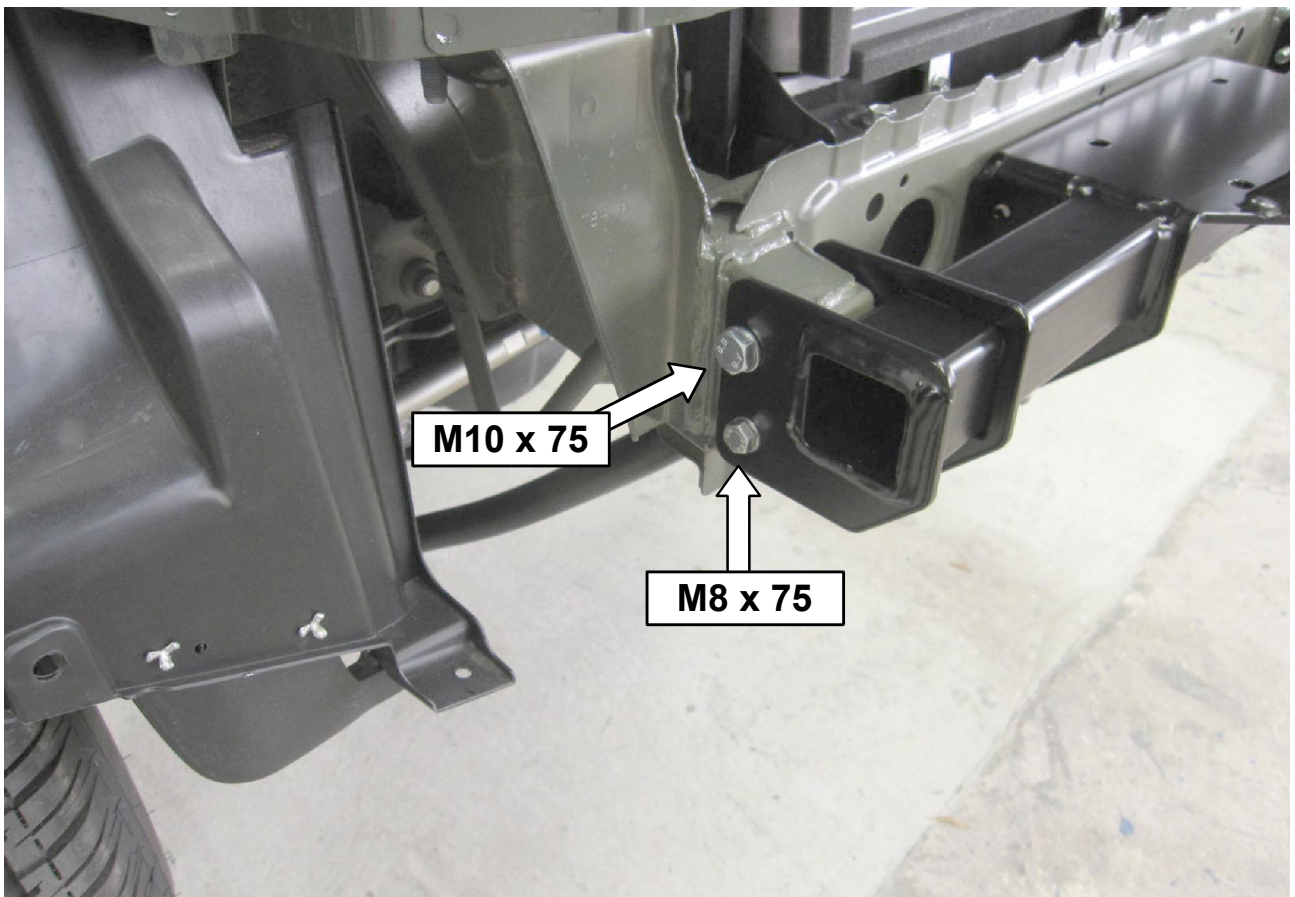

**7**

**Das Gleiche an der linken Seite! / The same at the left side!**

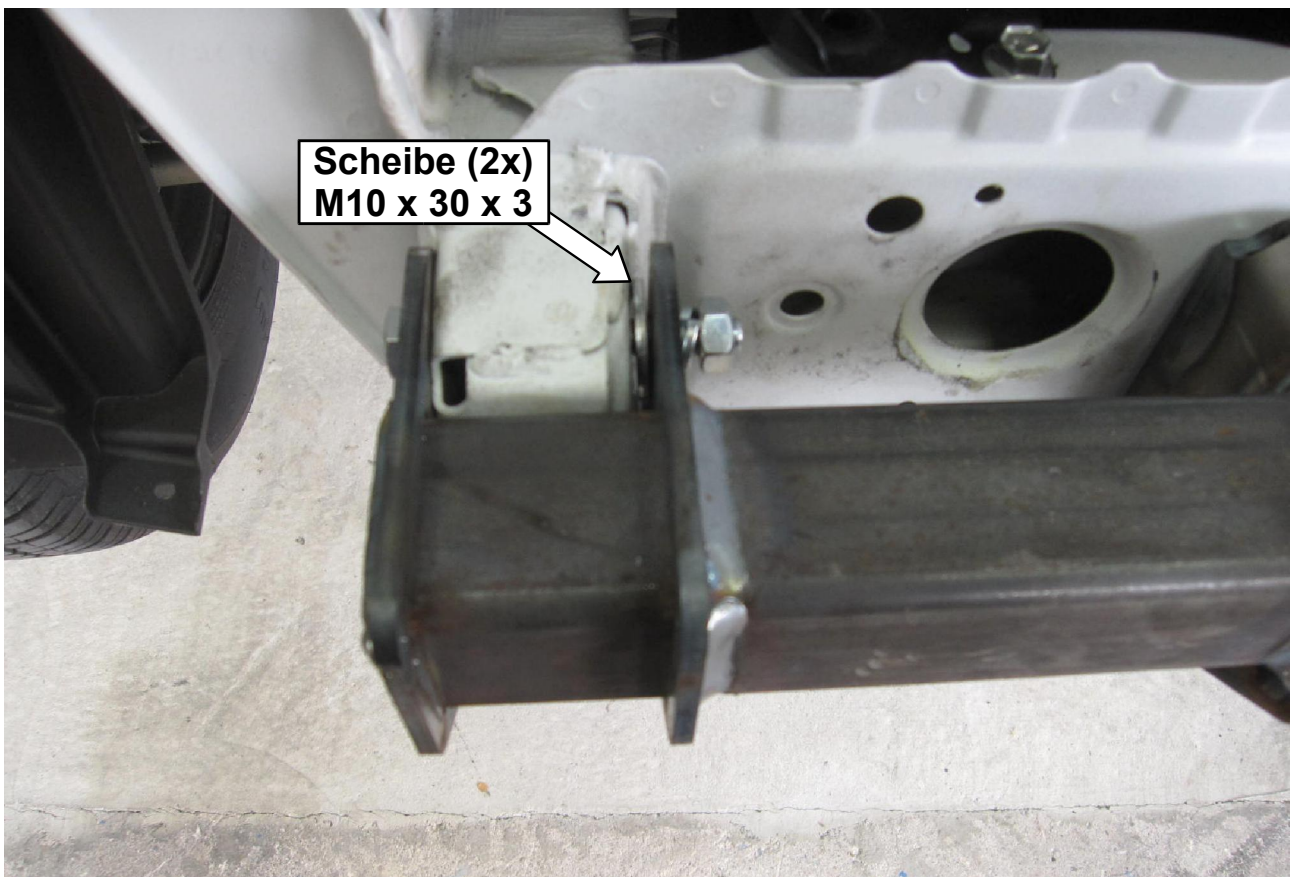

**8**

**Möglichen Spalt ausgleichen! / Compensate possible gap!  
Das Gleiche an der linken Seite / The same at the left side!**

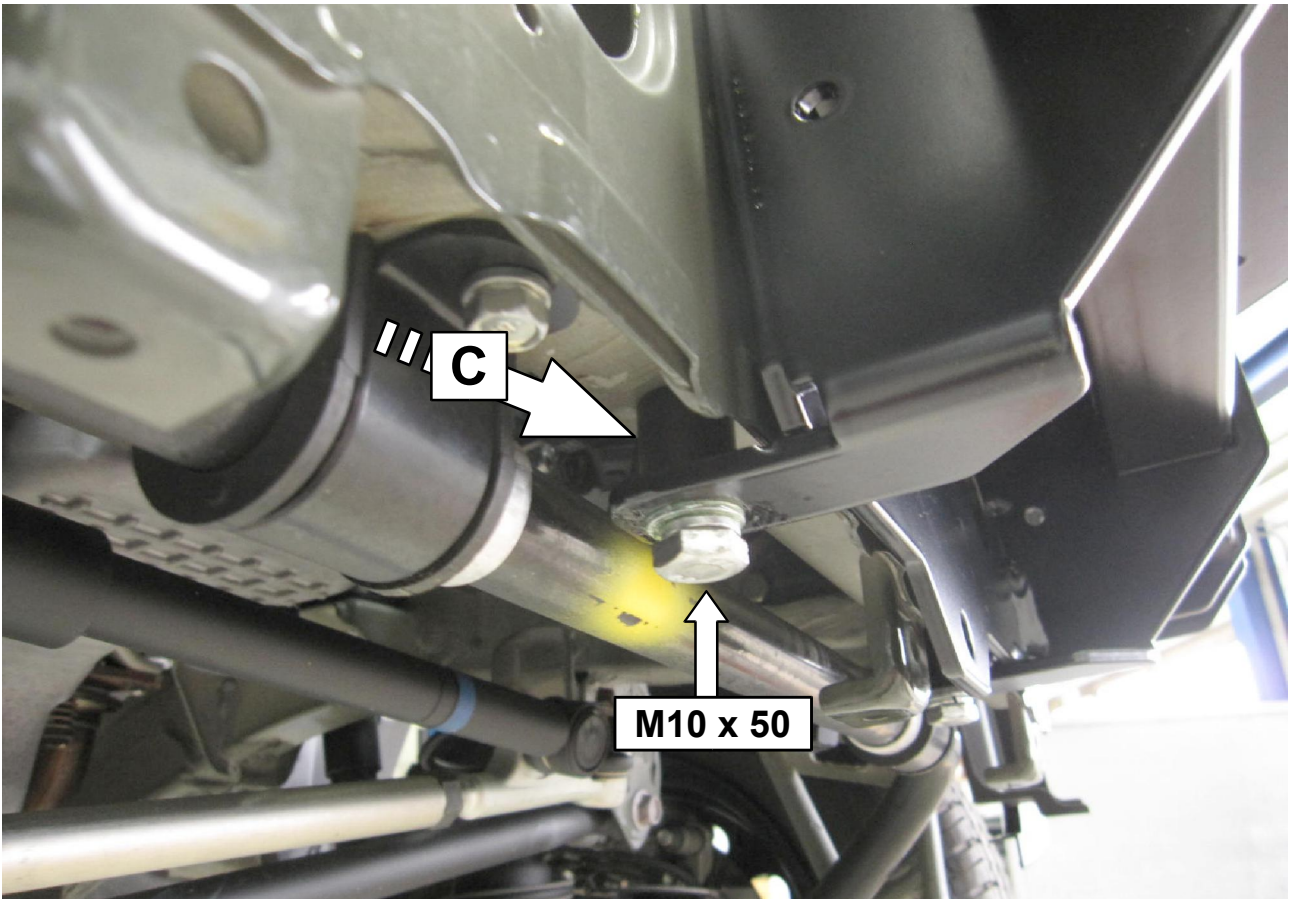

**9** Das Gleiche an der linken Seite! / *The same at the left side!*

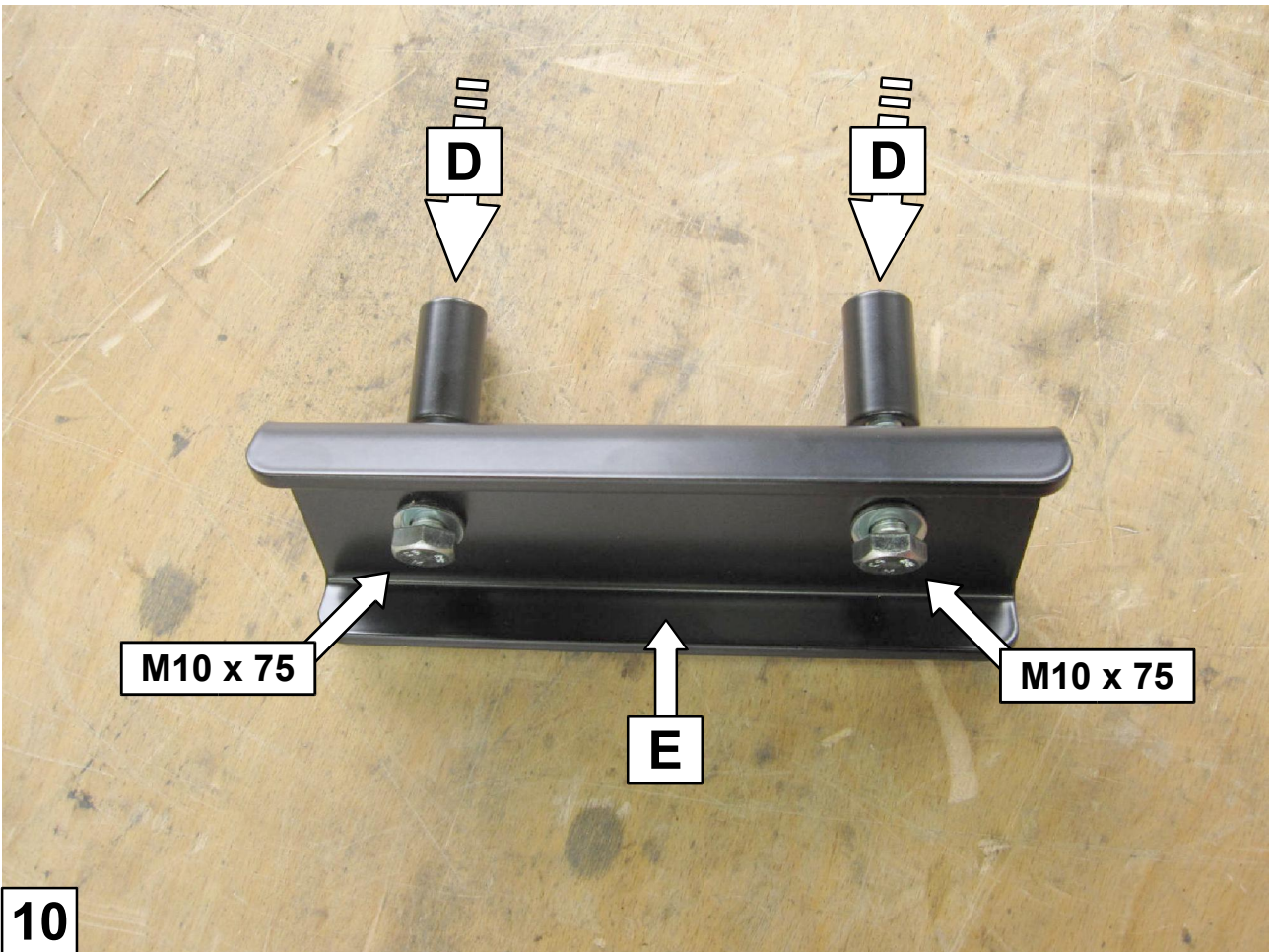

**10**

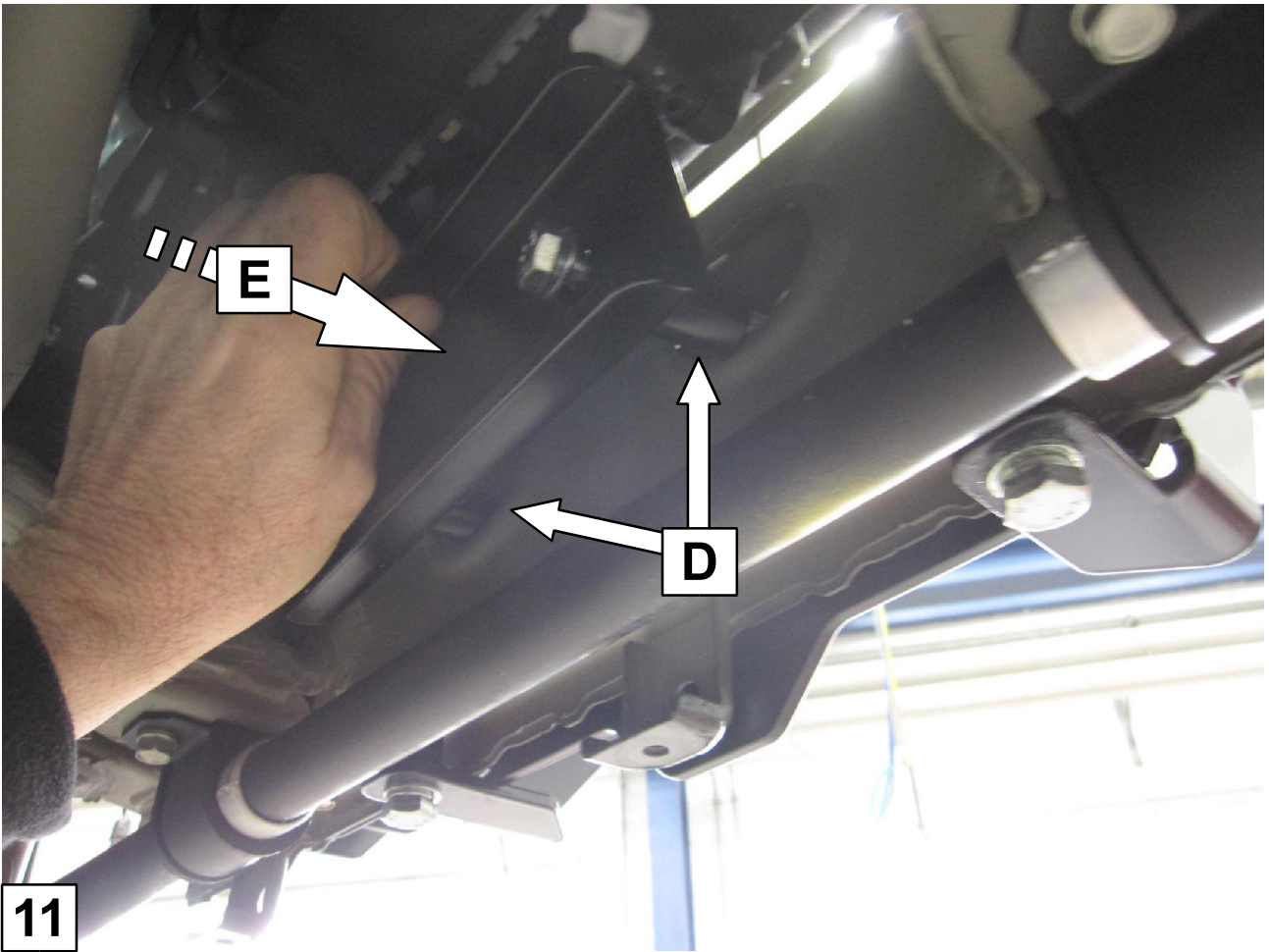



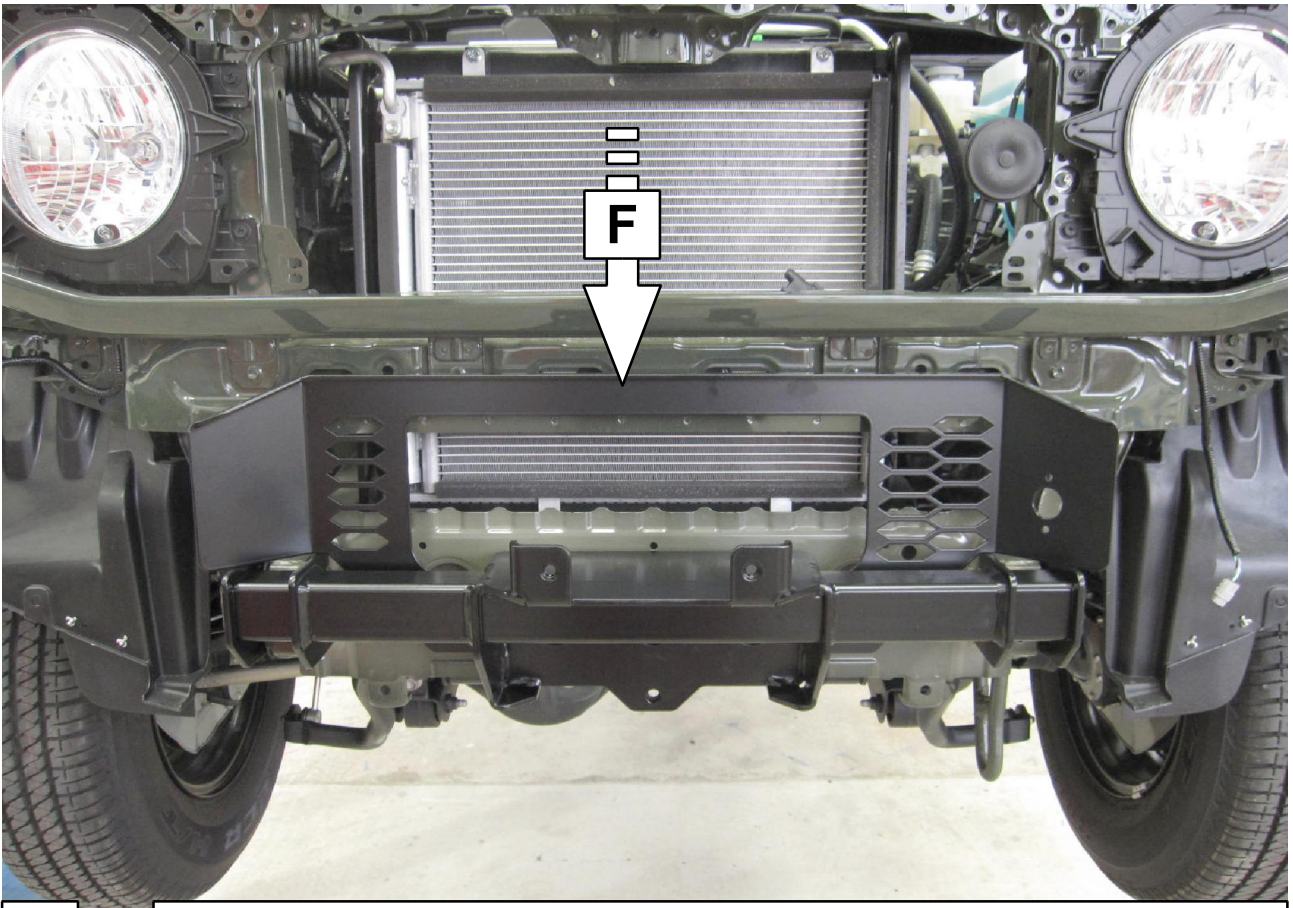

**13**

**Nur aufstecken! / Just put on!**

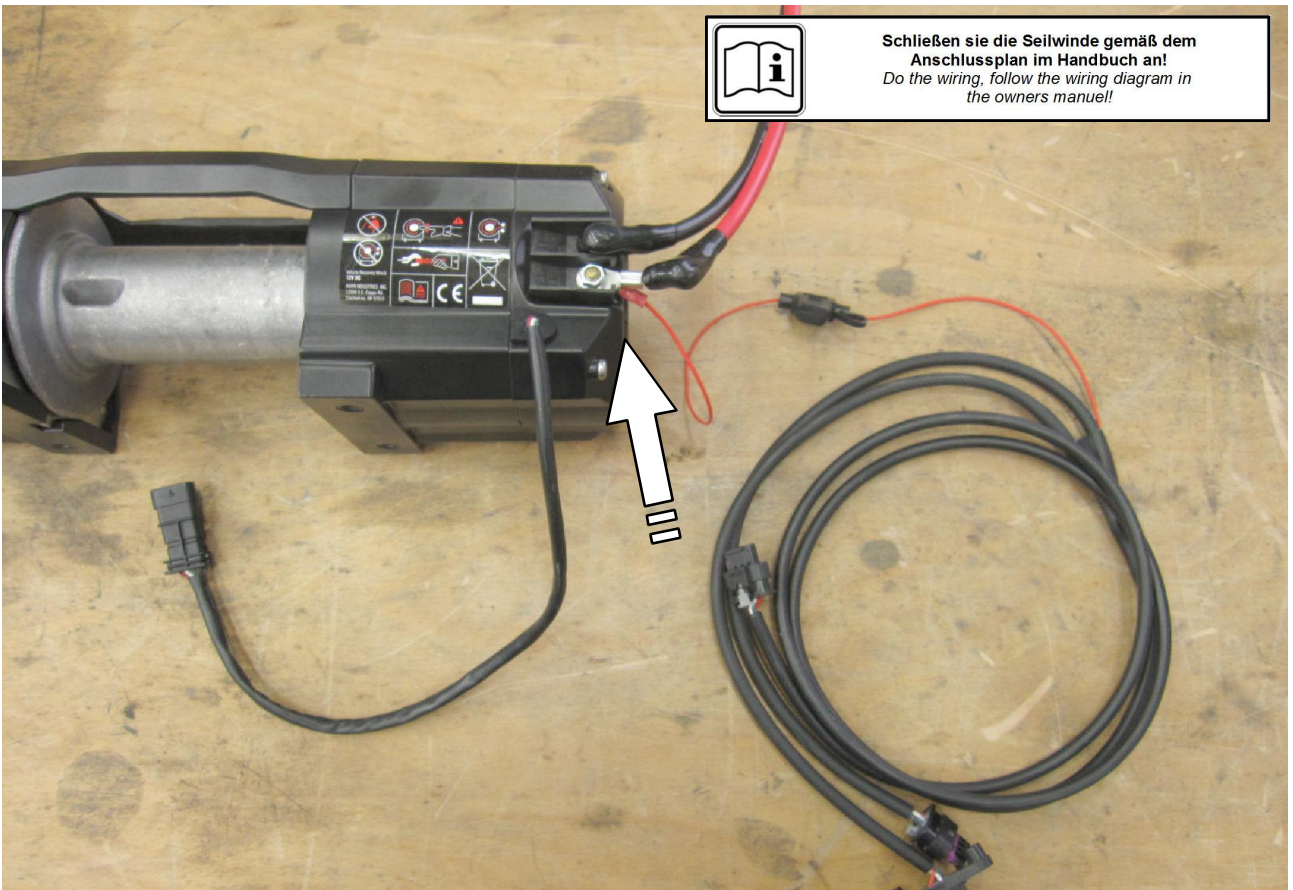

**Schließen sie die Seilwinde gemäß dem Anschlussplan im Handbuch an!**  
*Do the wiring, follow the wiring diagram in the owners manual!*

**14**

**Dünnes rotes Kabel an Plus Kontakt anschließen!**  
*Connect the thin red cable to the plus contact!*



15

Kabel durchziehen! / Pull the cable through!

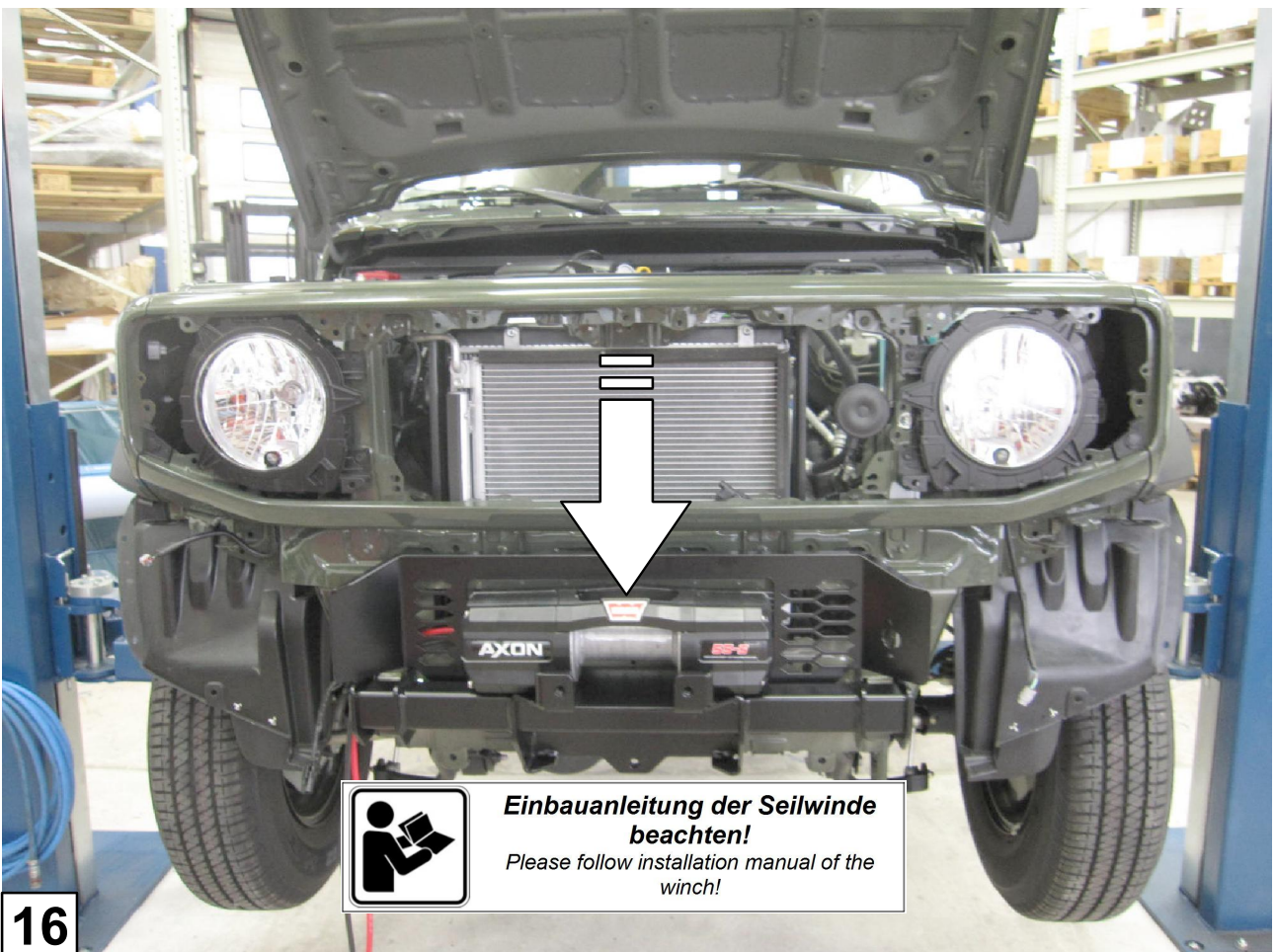

16

**Einbauanleitung der Seilwinde  
beachten!**  
Please follow installation manual of the  
winch!

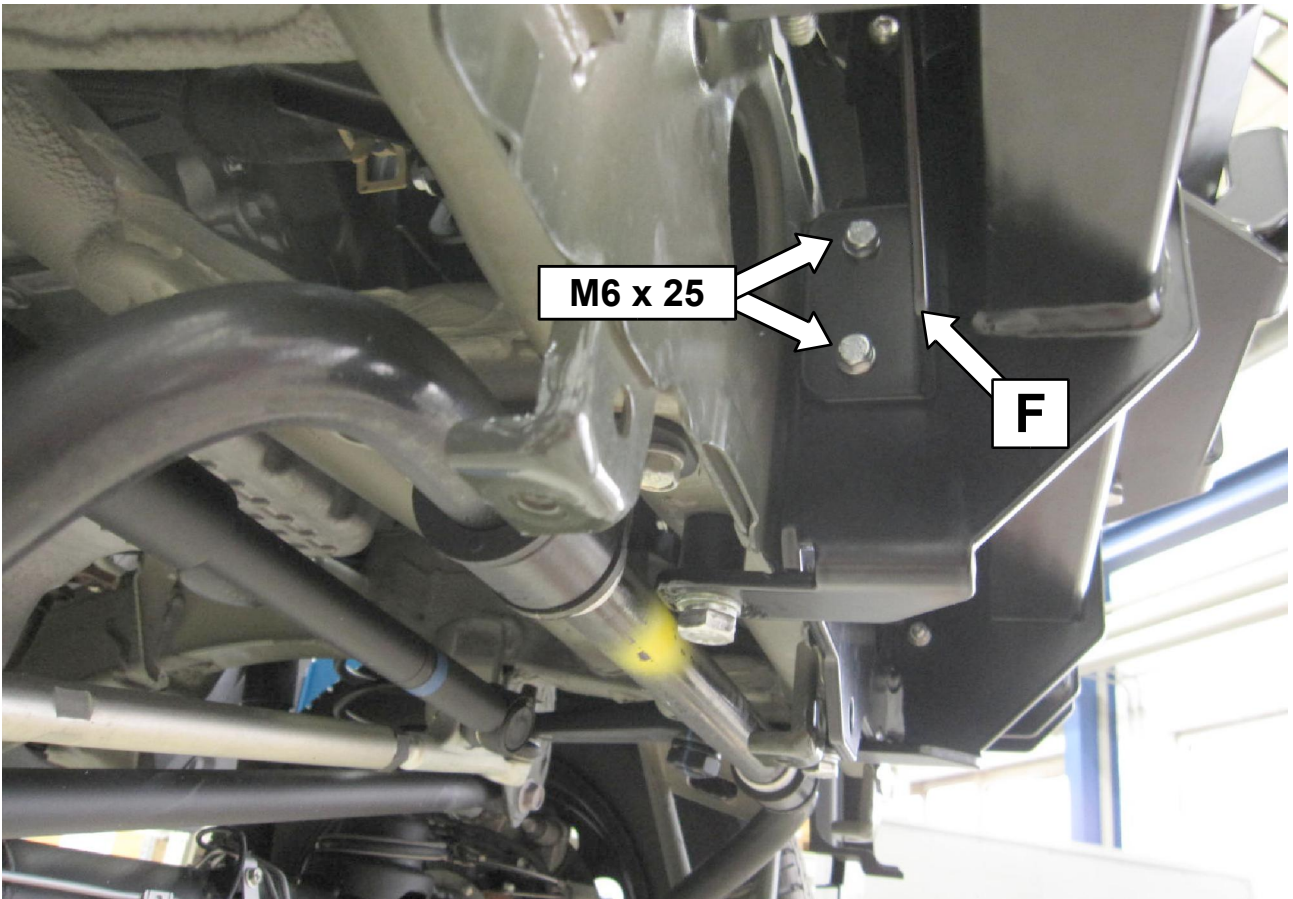

**17** Das Gleiche an der linken Seite! / *The same at the left side!*

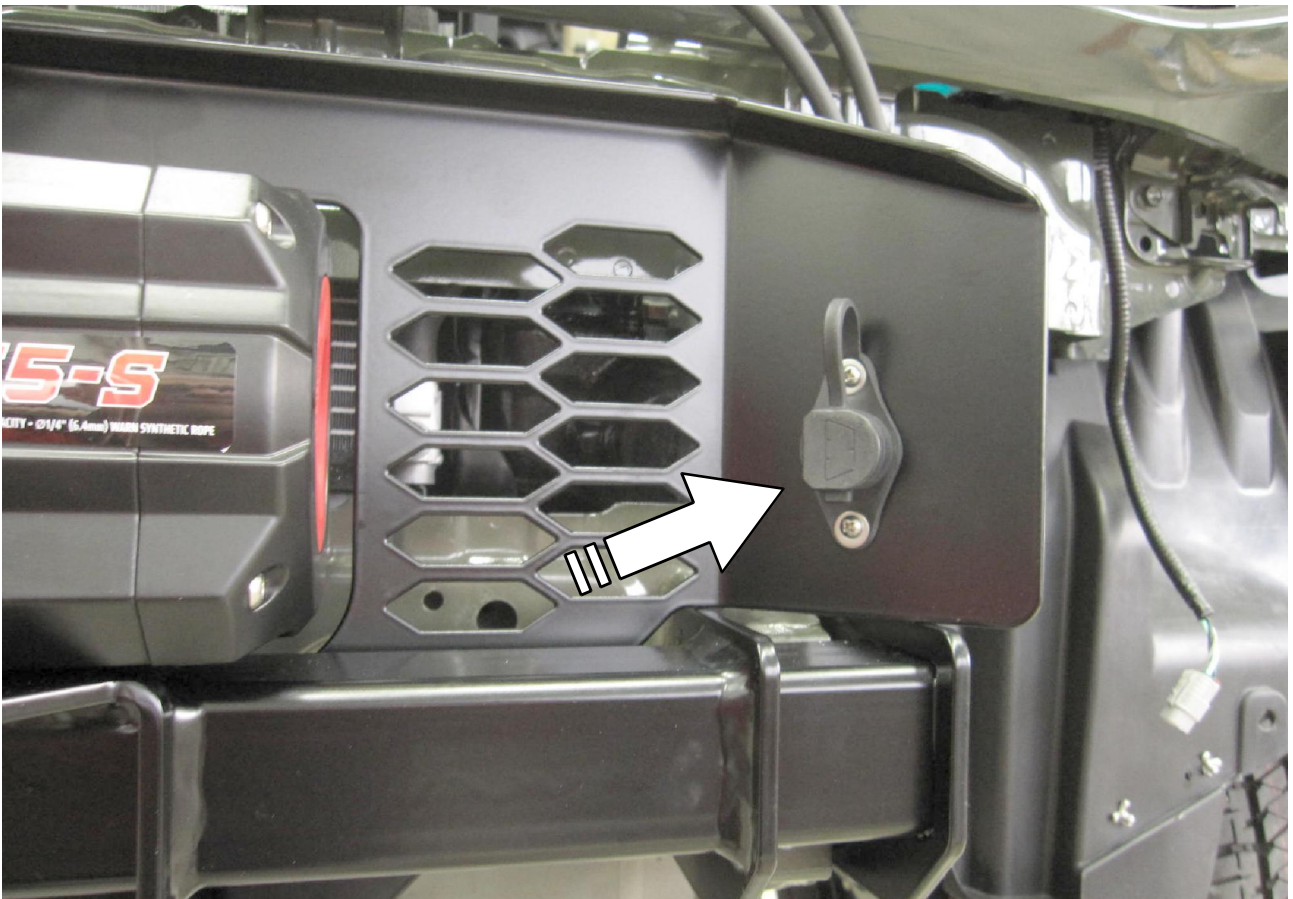

**18** Steckdose einbauen! *Install the socket!*

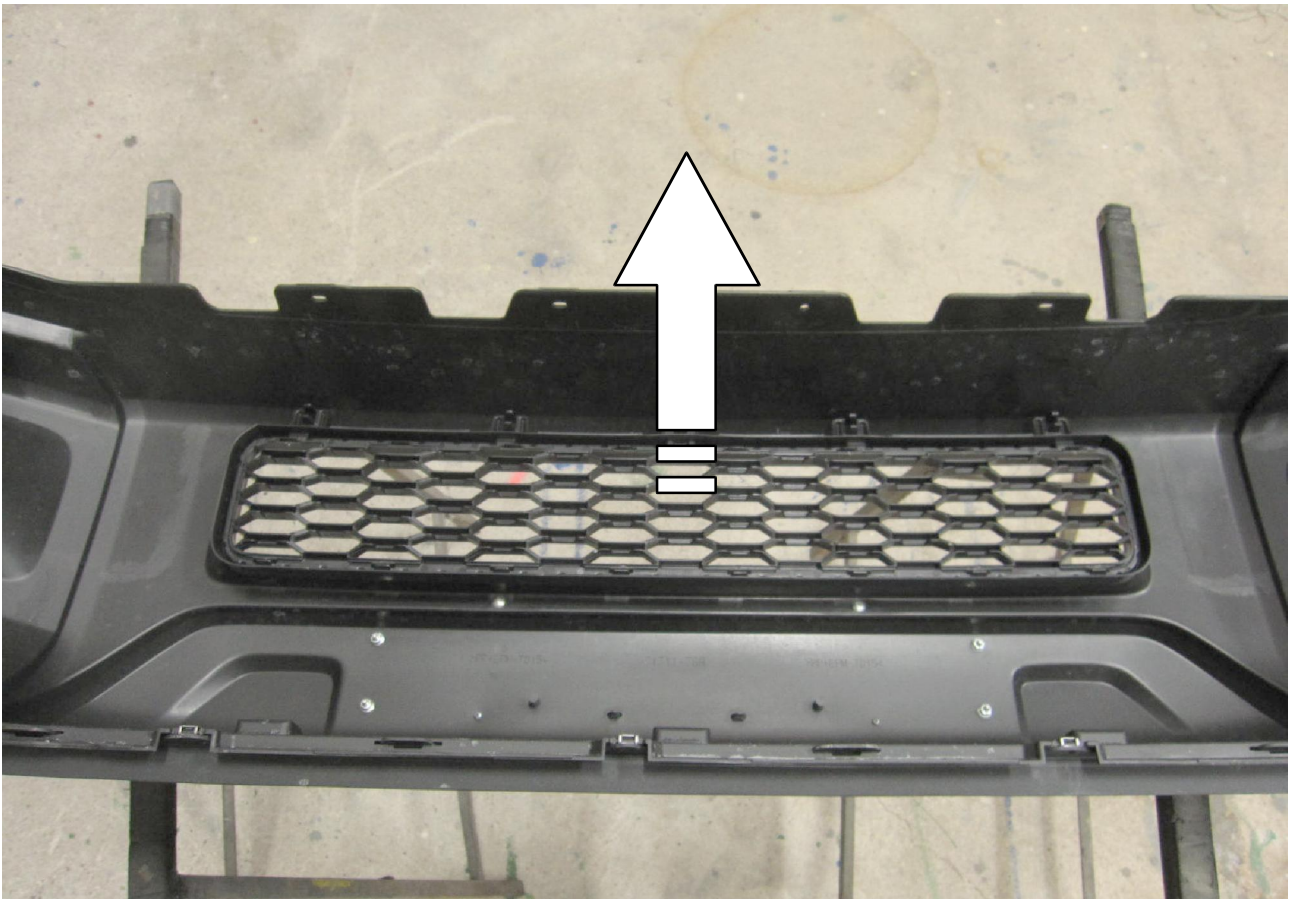

**19**

**Gitter herausnehmen! / Take out the grid!**



**20**

**Laschen abschneiden! Cut off the tabs!**

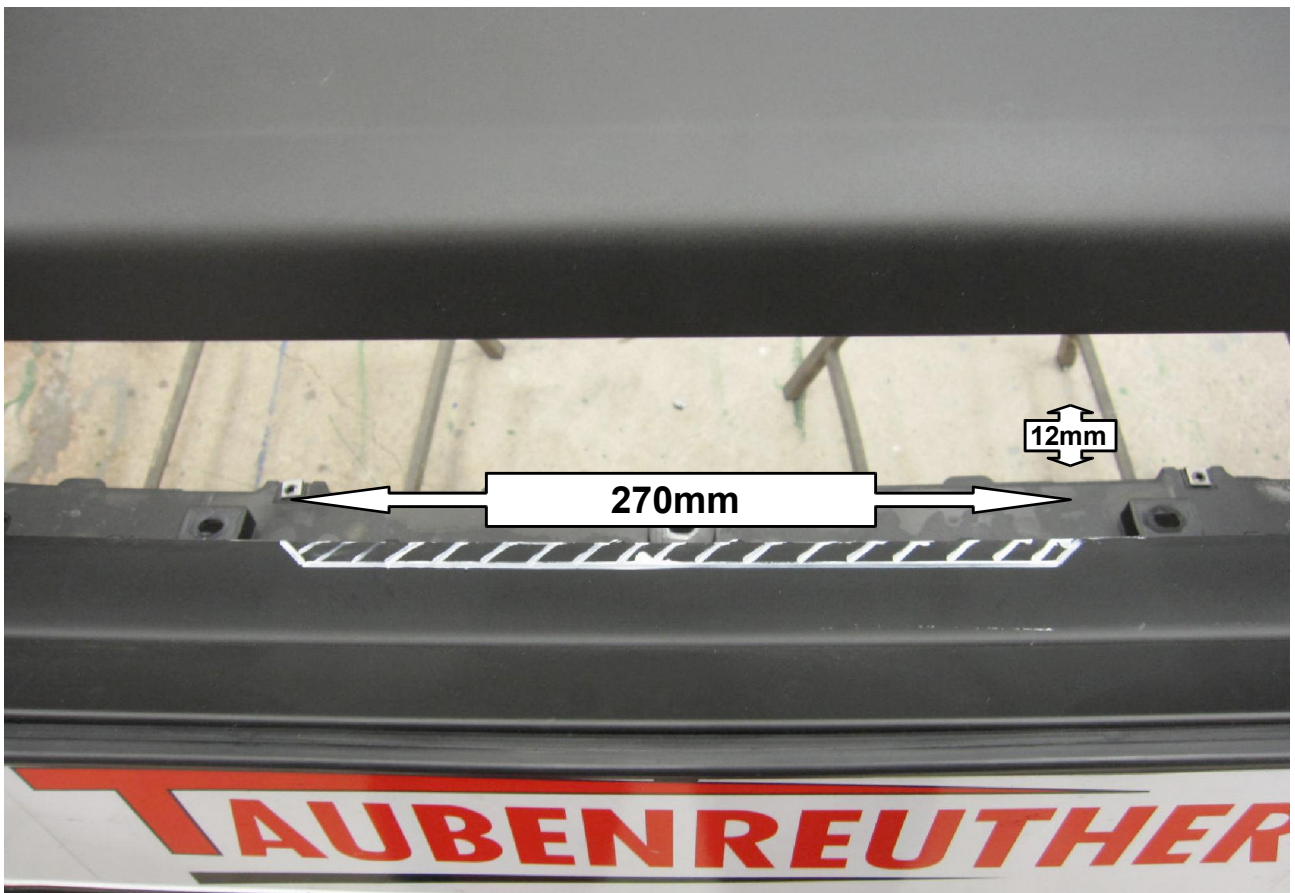

21

Ausschneiden! *Cut out!*



22

Stoßfänger wieder montieren! / *Mount the bumper again!*



**23**

**Rahmen wieder montieren! / Mount the frame again!**



**24**

**Kühlergrill wieder montieren! / Mount the radiator grill again!**



**25**

**Seil einhängen! Hook the rope!**

Schrauben Anzugsmomente	
Schraubengröße	Güteklasse - 8.8
M6	10 Nm
M8	25 Nm
M10	50 Nm
M12	87 Nm
M14	138 Nm
M16	210 Nm



**26**

**Alu Seilfenster 10-7612 optional verwendbar!**  
*Alu rope window 10-7612 optionally usable!*