

Anbauanleitung Seilwindenanbausatz

(wir empfehlen die Verwendung des Verlängerungskits 1-90394 für die Steckdose des Schaltkastens)

Fitting instruction winch mounting kit

(we recommend to use 1-90394 contactor box socket extension kit)

Mitsubishi L200 - KJ0T ab Bj.2016

Taubenreuther Best.nr.: 16 – 3880

Mitsubishi Best.nr.:

Z5745800 - Seilwinde 3,6to WARN M 8000 inkl.Einbaukit

Z5745900 - Seilwinde 4,1to WARN XD 9000 inkl.Einbaukit

AL: 2050-04



**Hier sehen sie den fertig montierten Seilwindenanbausatz.
Bevor sie mit der Montage beginnen, lesen sie bitte diese Anleitung
und das Benutzerhandbuch der Seilwinde gut durch.**

*Before you start fitting, please read and understand this instruction manual
and the owners manual of the winch.*

Stückliste / parts list
Seilwindenanbausatz / winch mounting kit
Mitsubishi L200 ab Bj.2015

Best. Nr. 16 – 3880

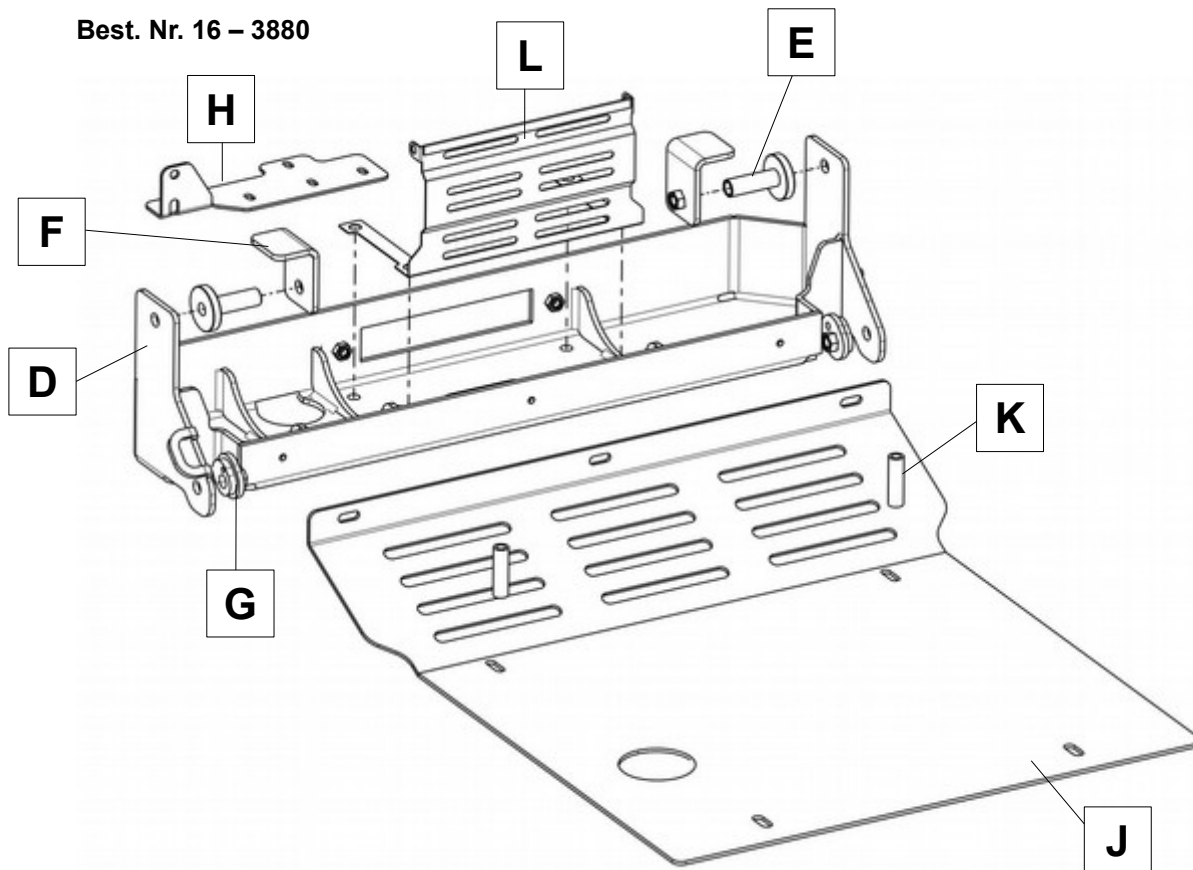

1 x Freilaufhebel 1-82463-K (A)
(nicht im Bild)

3 x 1100 mm Kabel 35² schwarz mit je
 2 x Kabelschuh 35² x 8mm (B)

1 x Kabel 1,5² x 1000 mm mit
 1 x Ringzunge rot M8 (C)
 1 x Rundstecker rot 0,5-1mm

1 x Seilwindenaufnahme (D)
 2 x Distanzhülse (E)
 2 x Gewindegewinkel (F)
 2 x Befestigungsplatte (G)
 1 x Schaltkastenhalter (H)

1 x Rundsteckülse rot 0,5-1mm (i)

1 x Unterfahrerschutz (J)
 2 x Distanzrohr (K)

1 x 16-0512, Schutzblech hinten (L)

1 x Anbauanleitung AL 2050
1 x Teilegutachten
1 x Aufkleber Kennzeichnung

2 x Schraube M 12 x 100
 2 x Schraube M 12 x 40
 4 x U-Scheibe M 12 x 30 x 3
 4 x Federring M 12

3 x Schraube M 8 x 16
 3 x U-Scheibe M 8 x 25 x 2
 3 x Federring M 8

2 x Senkkopfschraube M 8 x 40
 2 x Senkkopfschraube M 8 x 80
 4 x Senkscheibe 8,4 (M)
(nicht im Bild)

4 x Mutter M 8
 2 x U-Scheibe M 8
 2 x Federring M 8

Schrauben Anzugsmomente

Schraubengröße	Güteklasse - 8.8
M6	10 Nm
M8	25 Nm
M10	50 Nm
M12	87 Nm
M14	138 Nm
M16	210 Nm



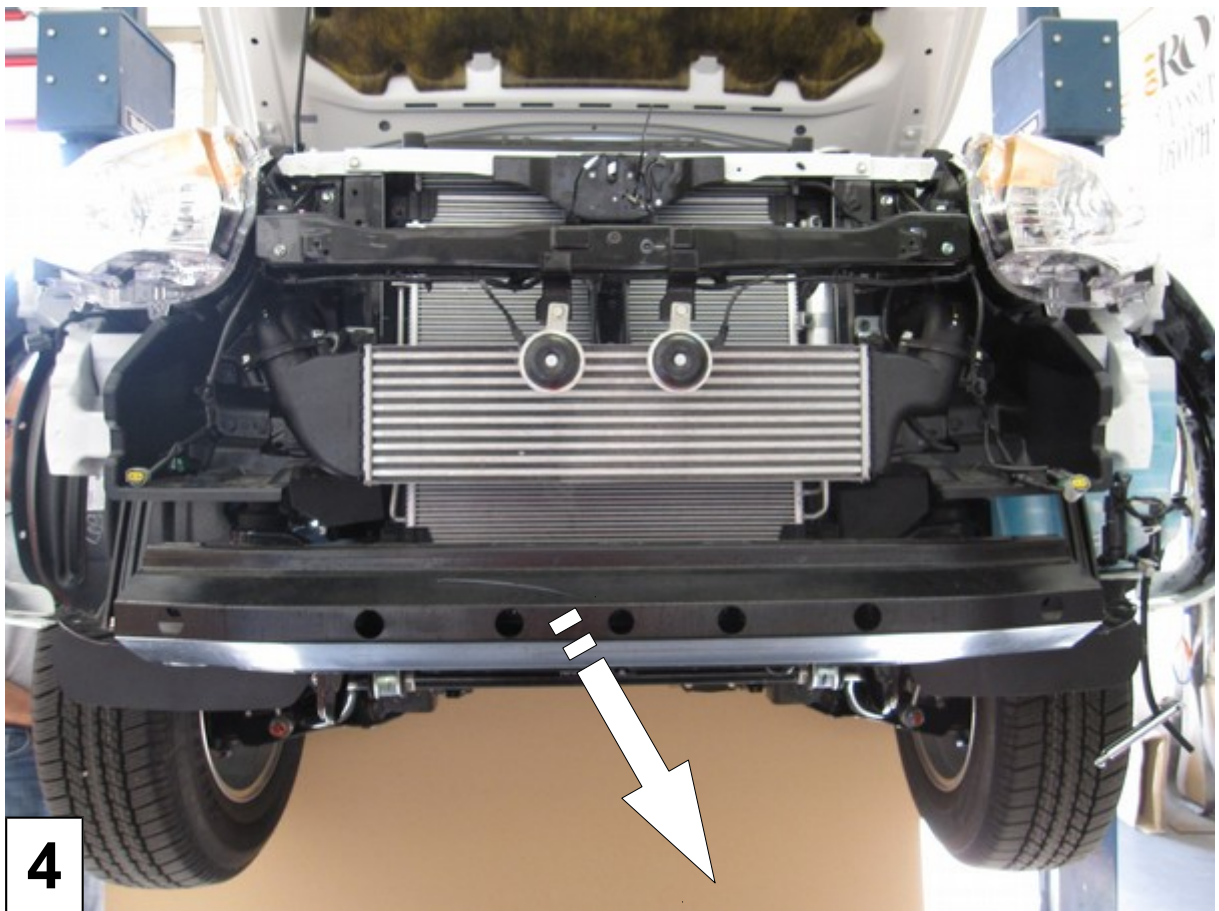



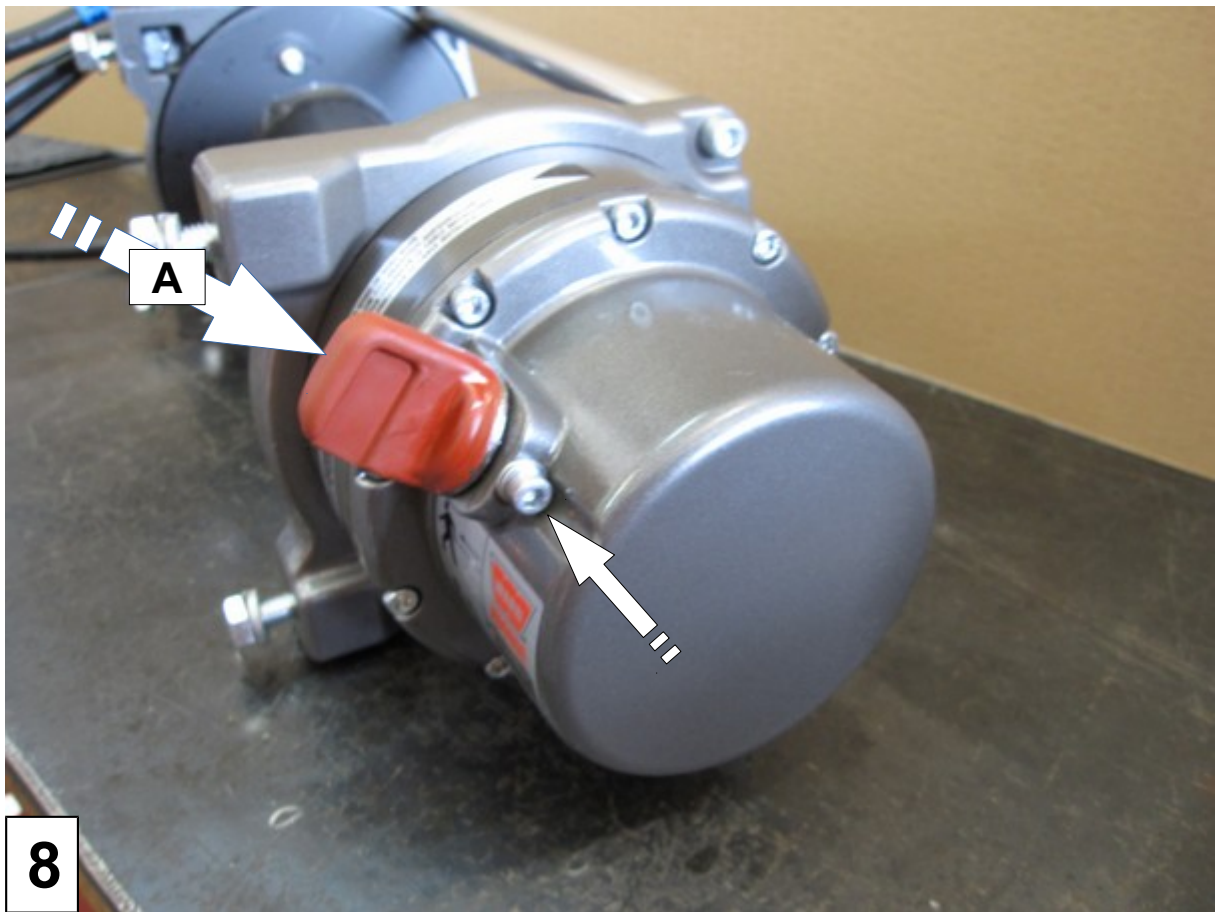

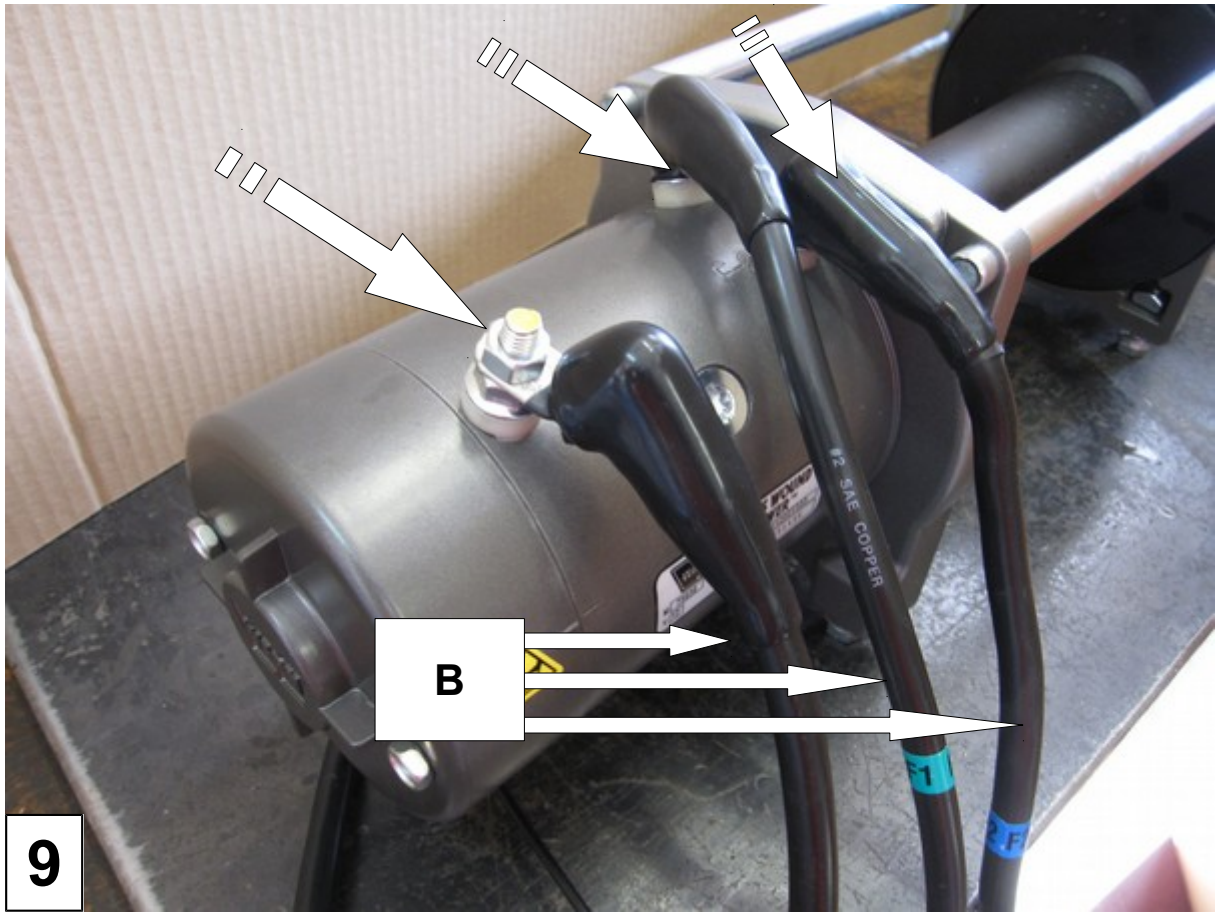

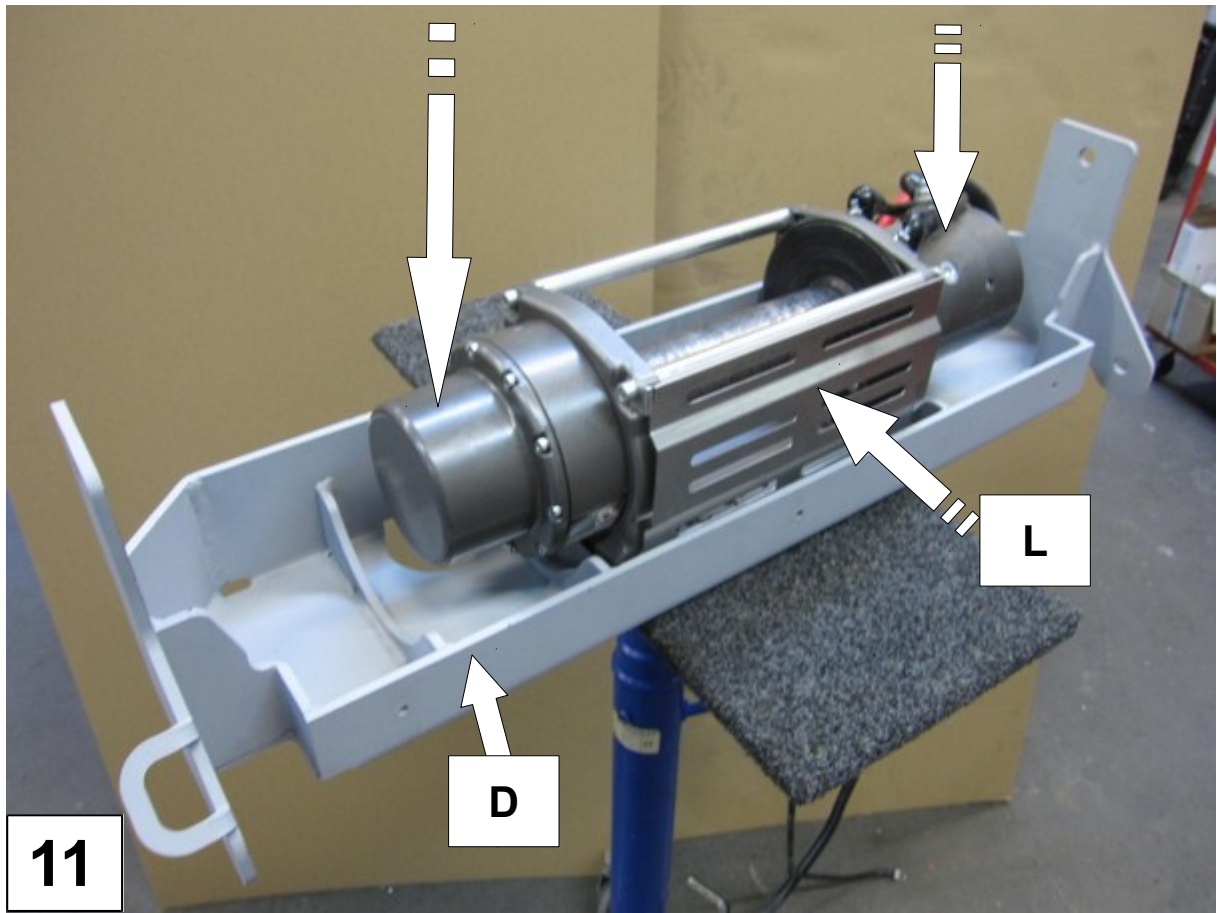

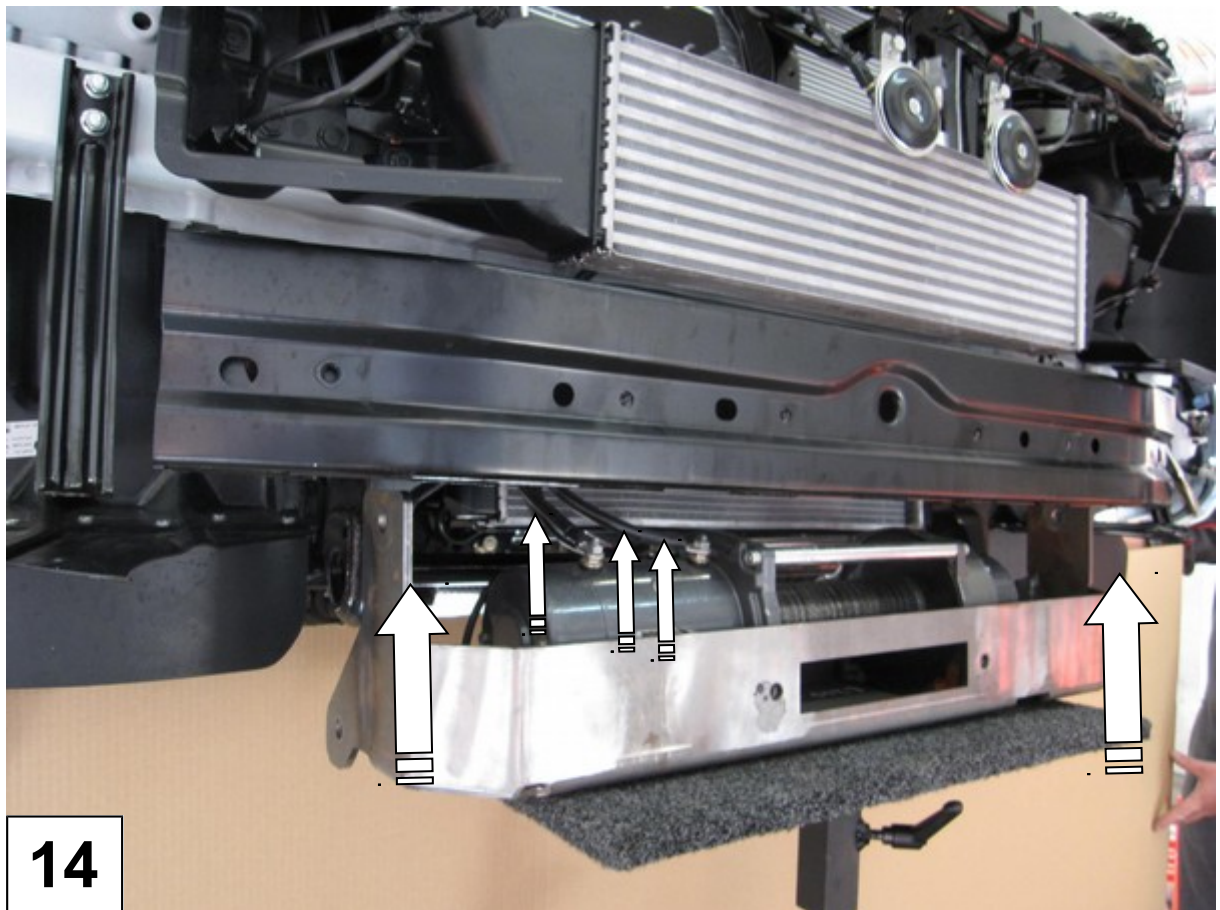
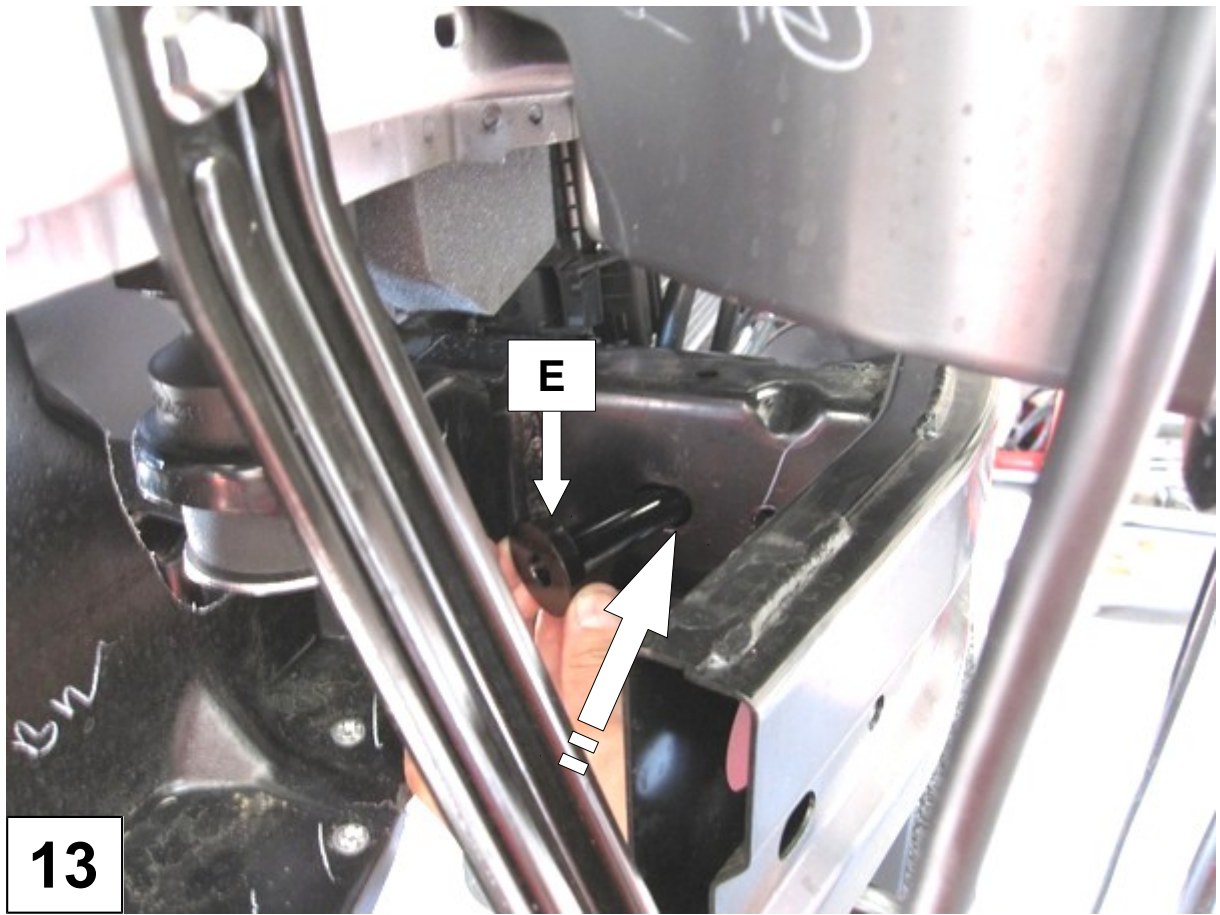

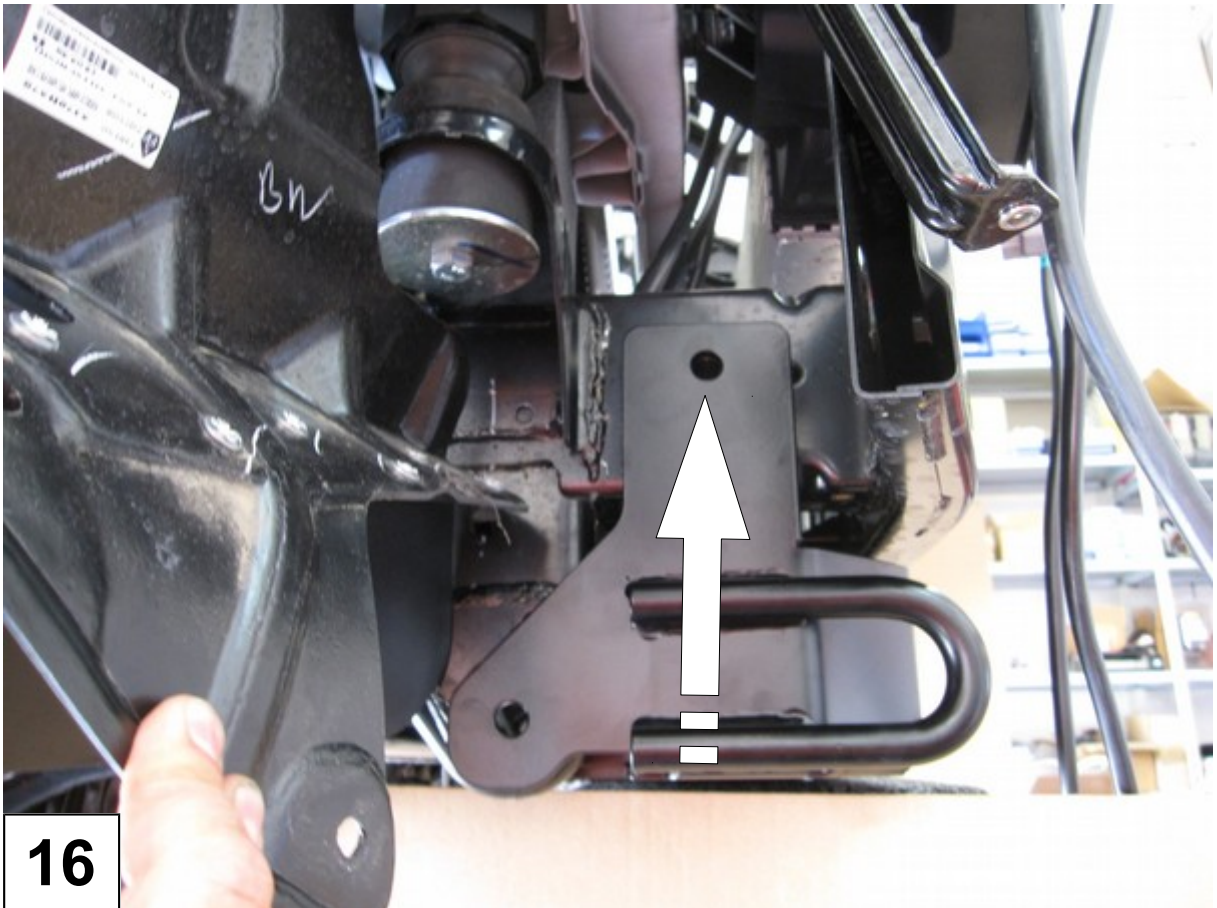
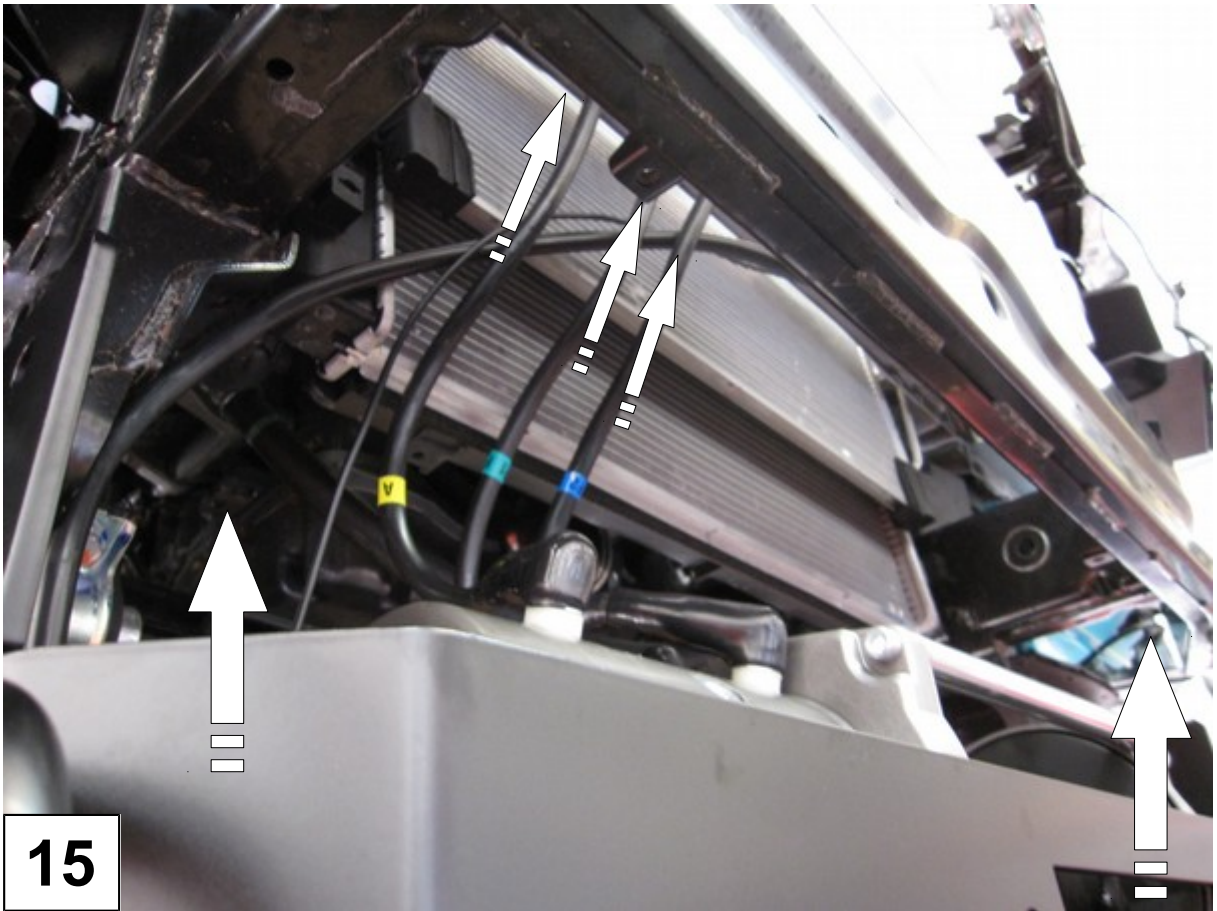

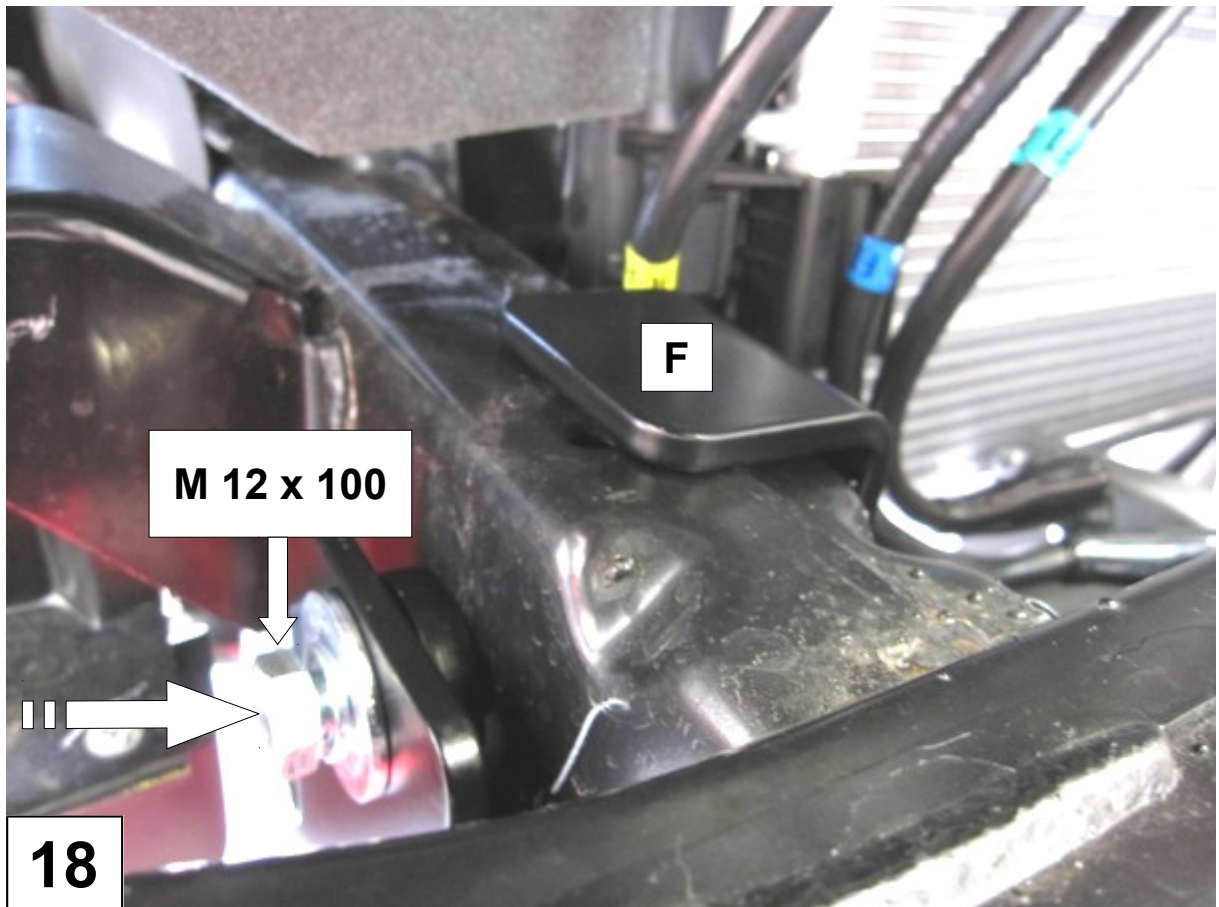
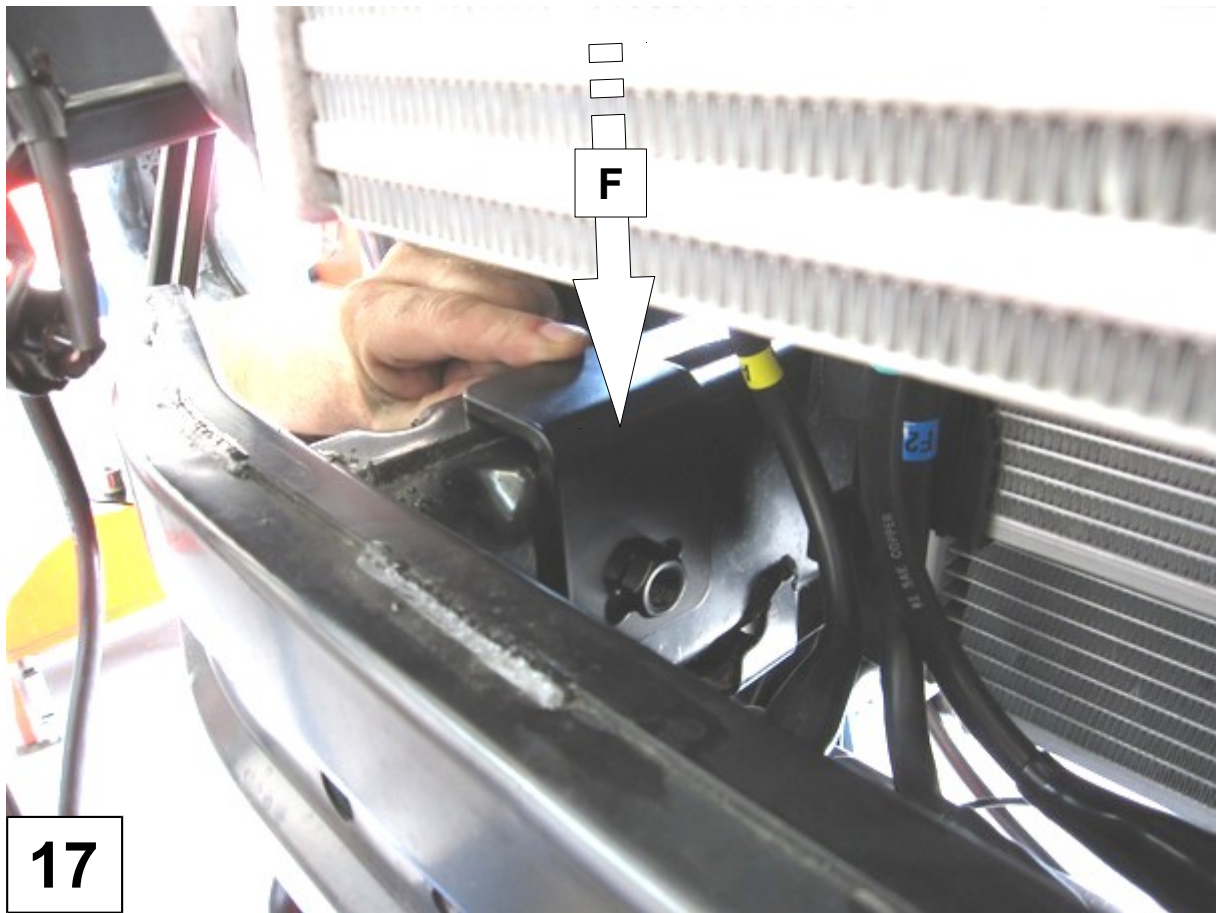

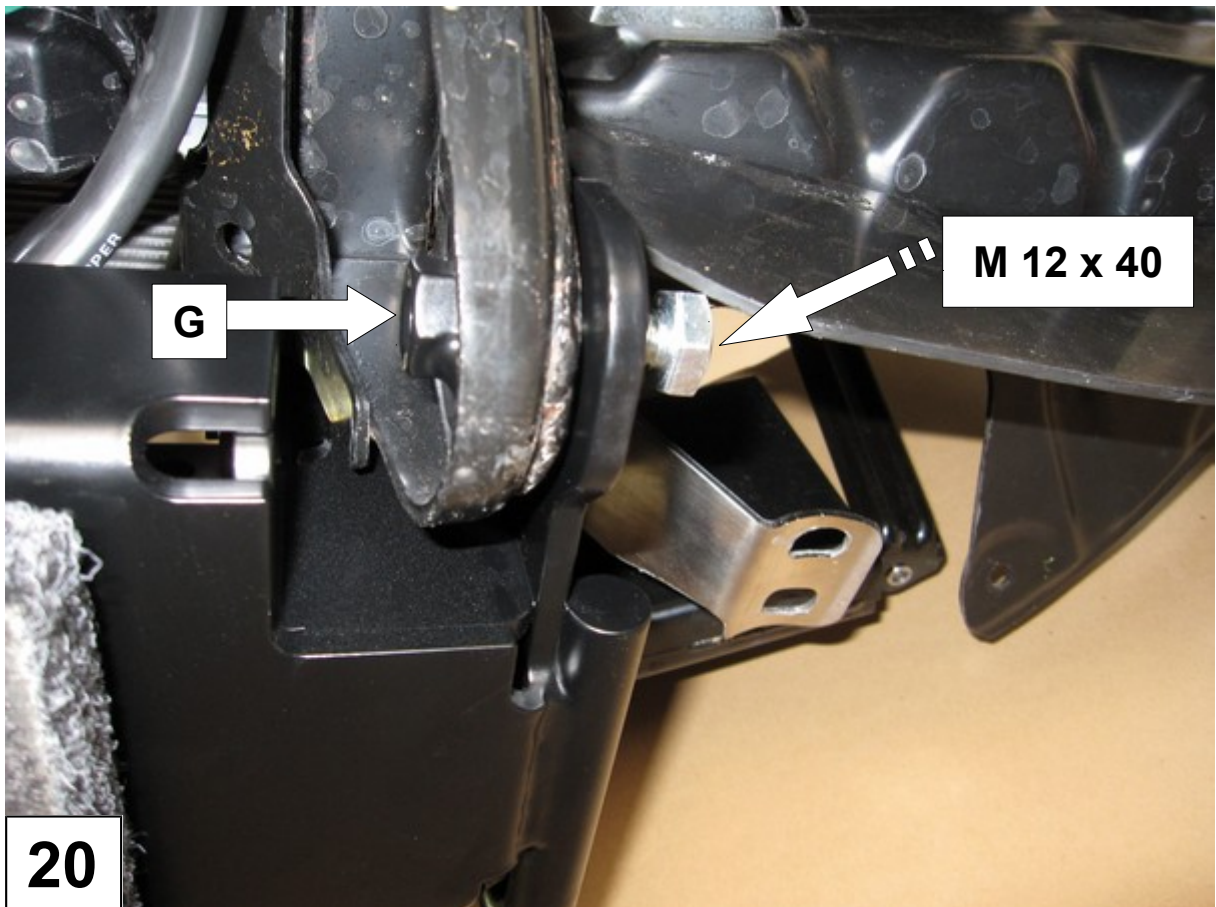
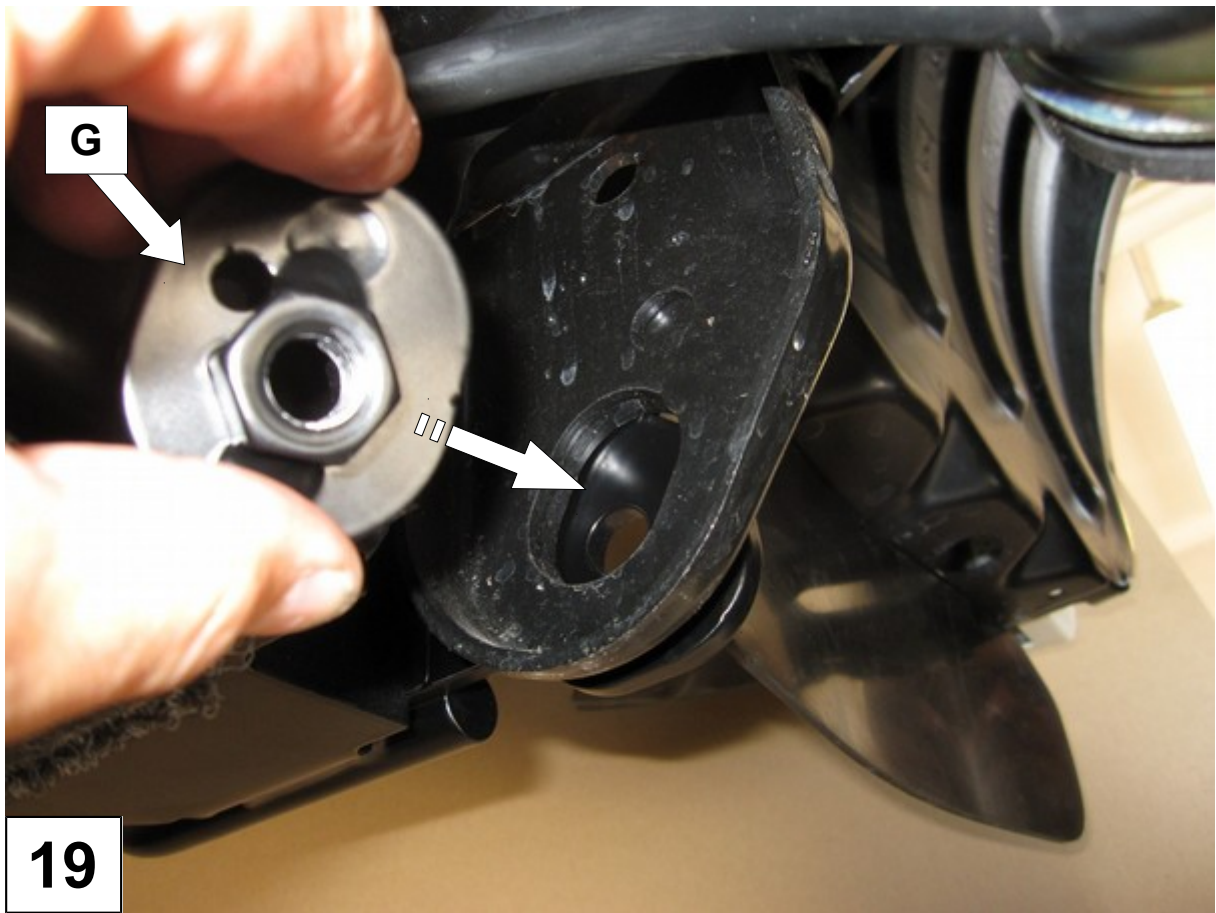

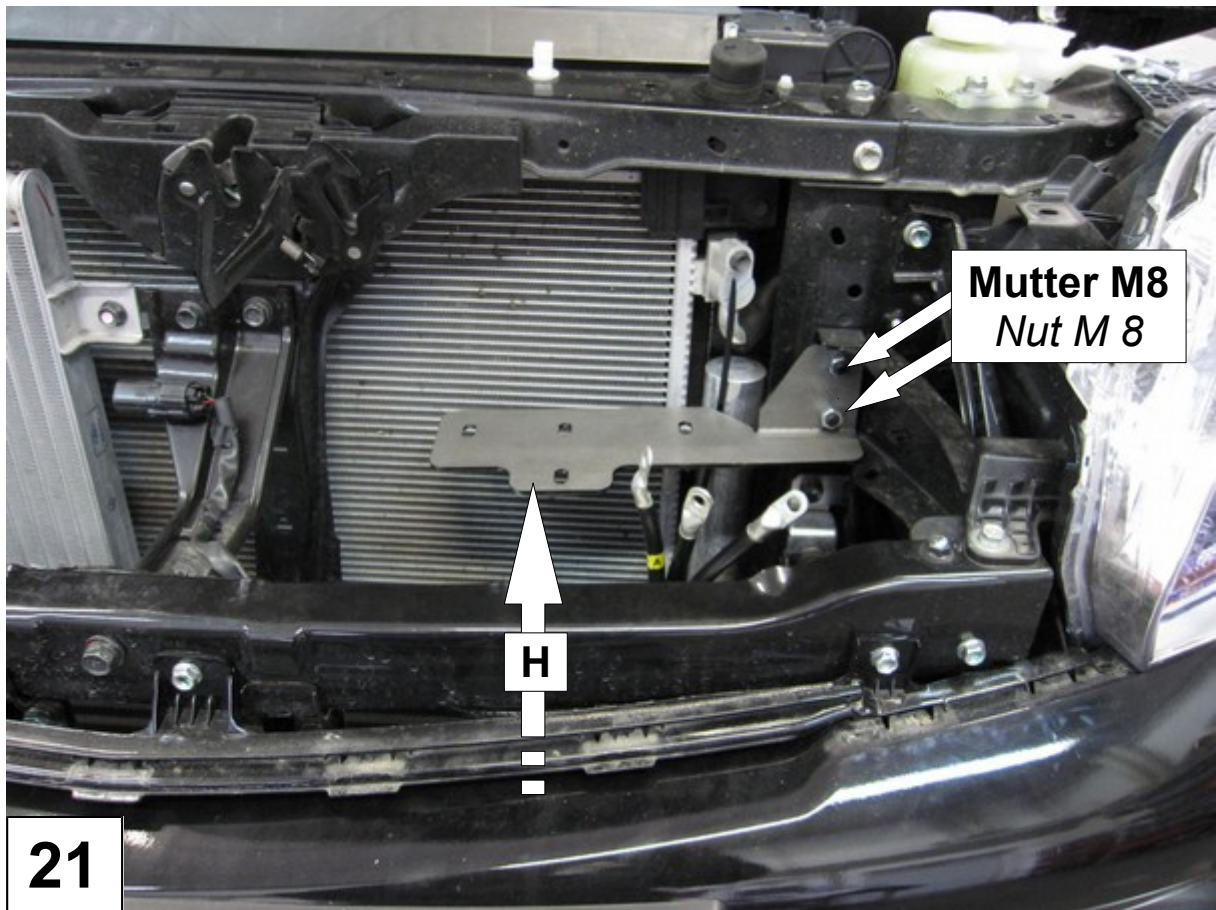

21

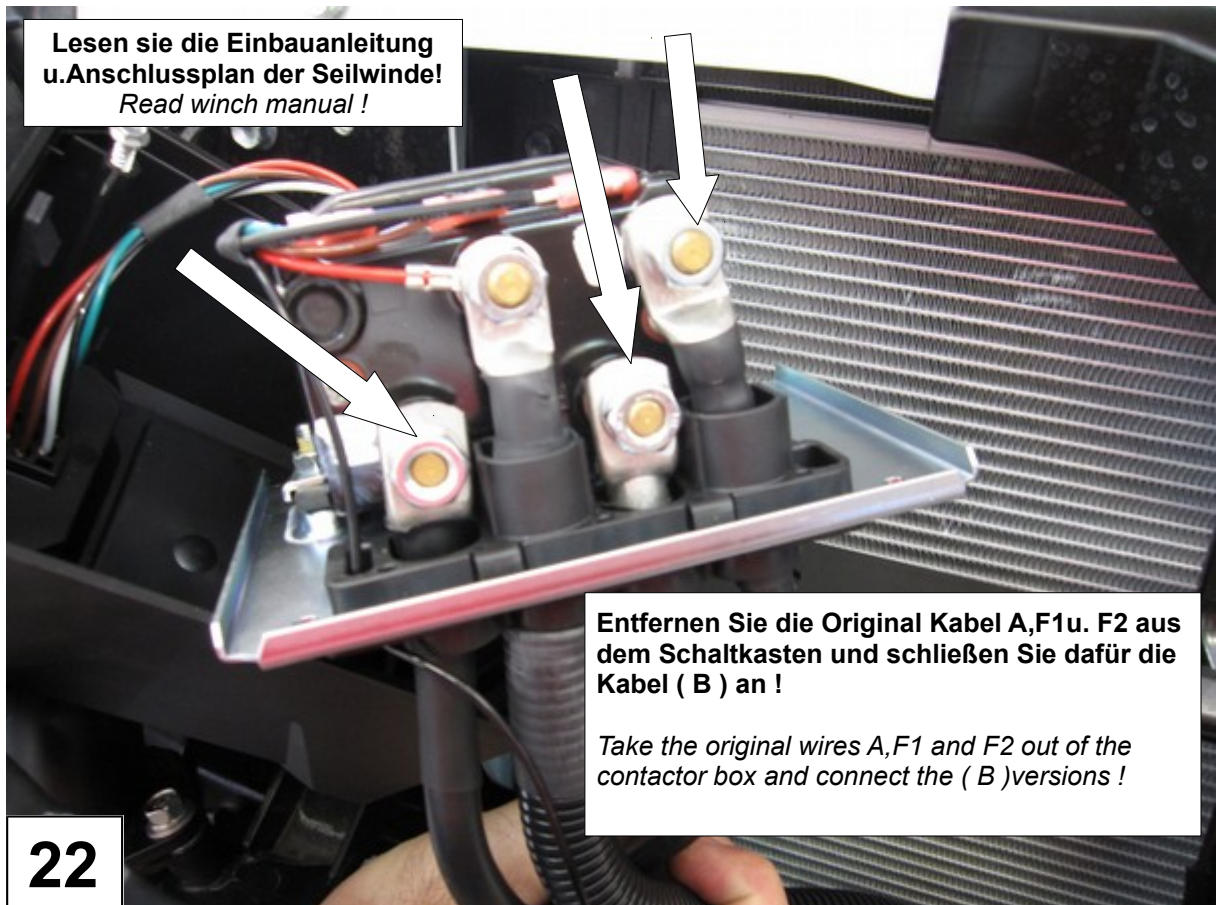

Lesen sie die Einbauanleitung
u. Anschlussplan der Seilwinde!
Read winch manual !

Entfernen Sie die Original Kabel A, F1 u. F2 aus dem Schaltkasten und schließen Sie dafür die Kabel (B) an !

Take the original wires A, F1 and F2 out of the contactor box and connect the (B) versions !

22

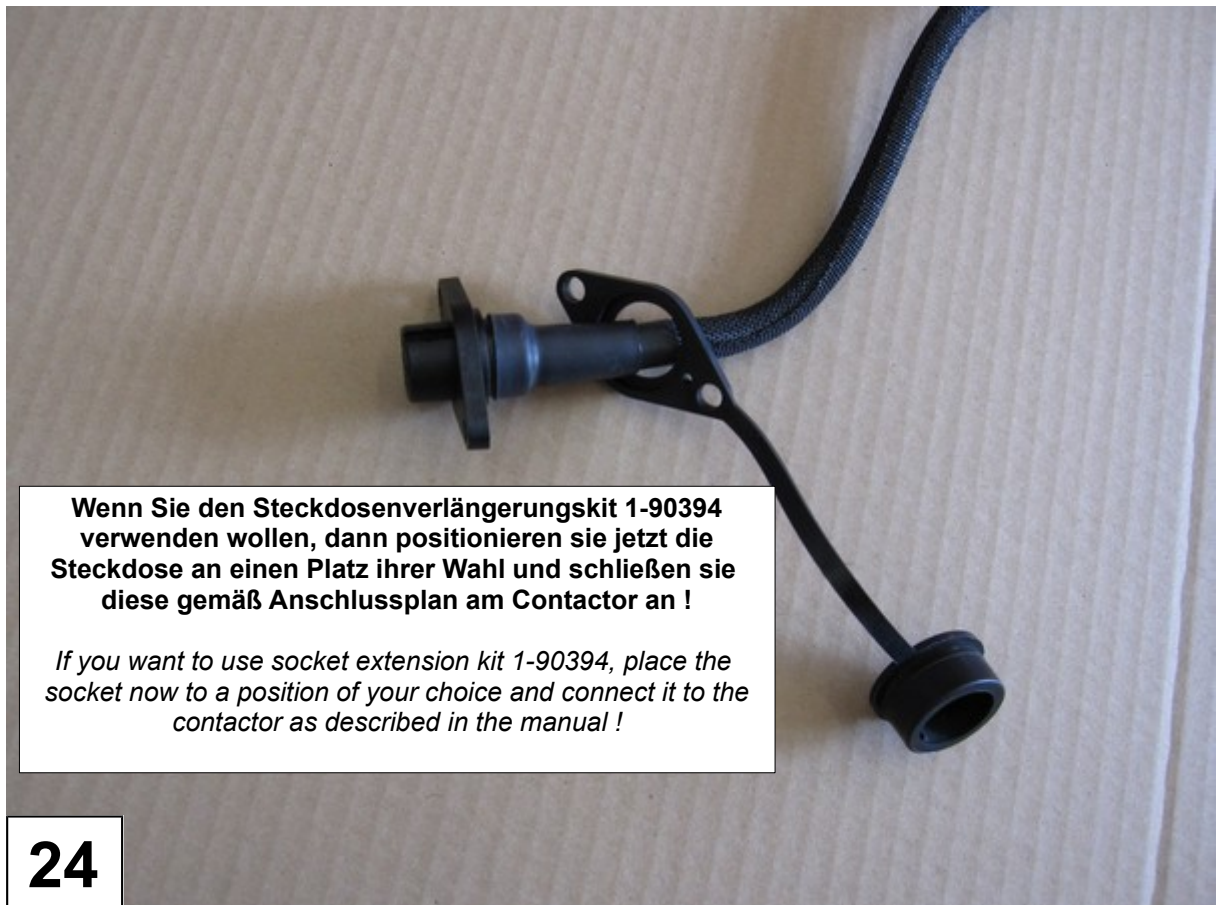
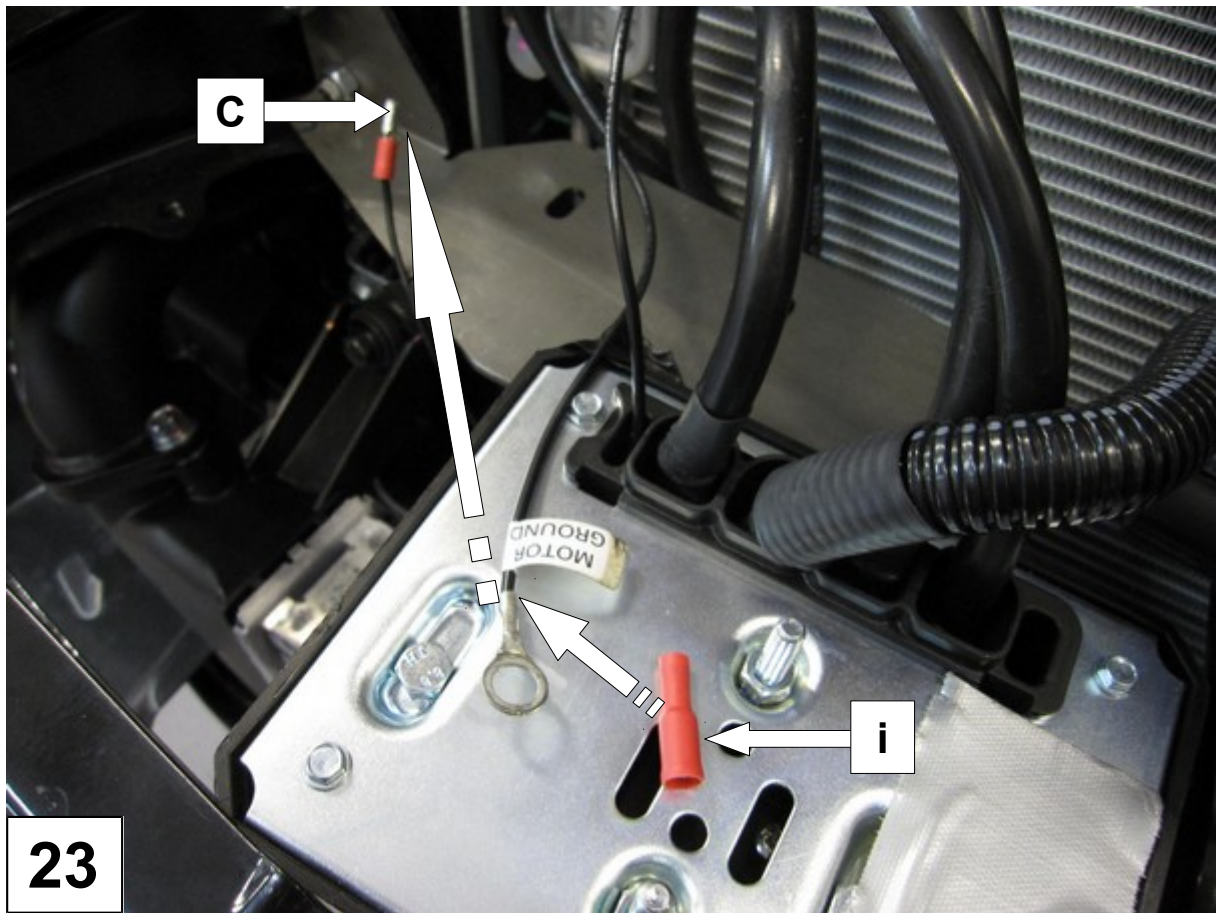

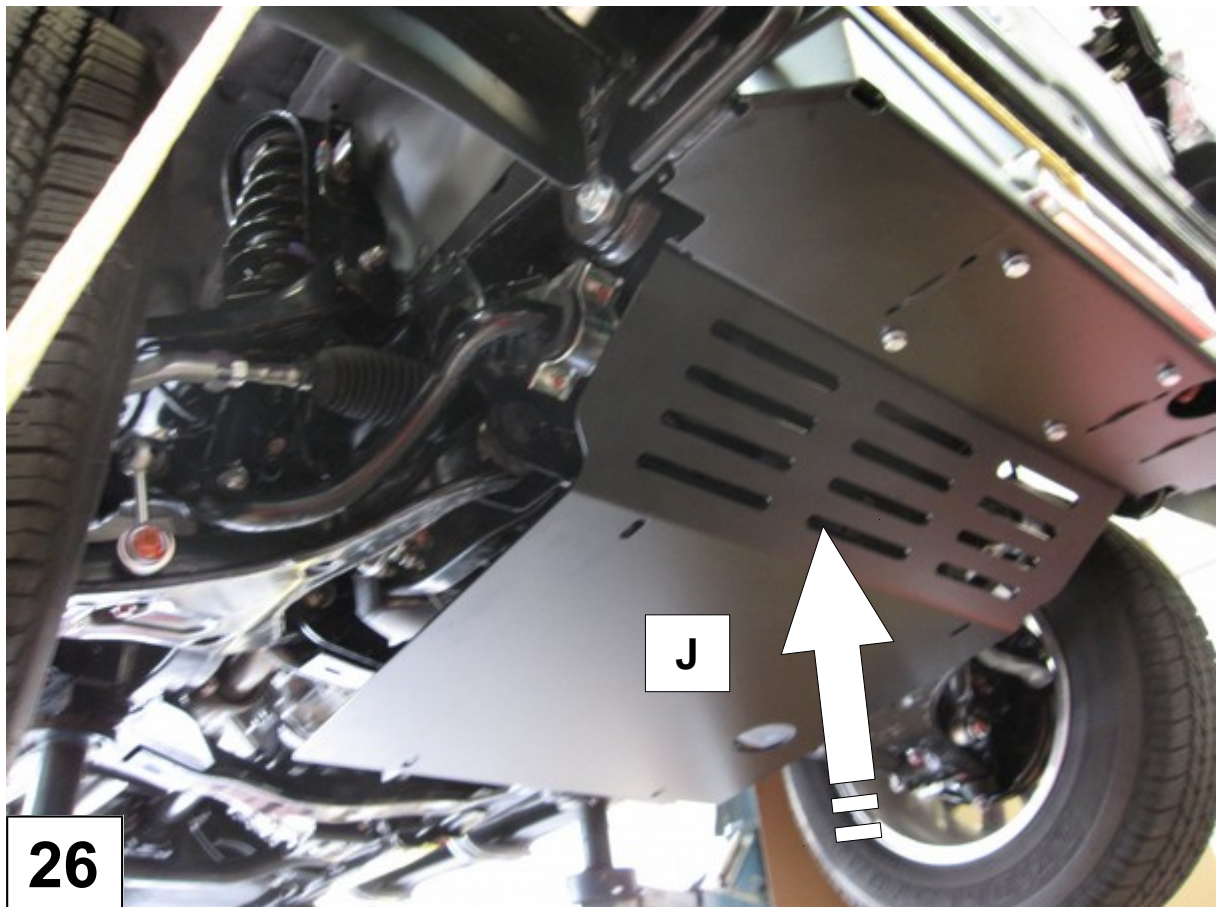
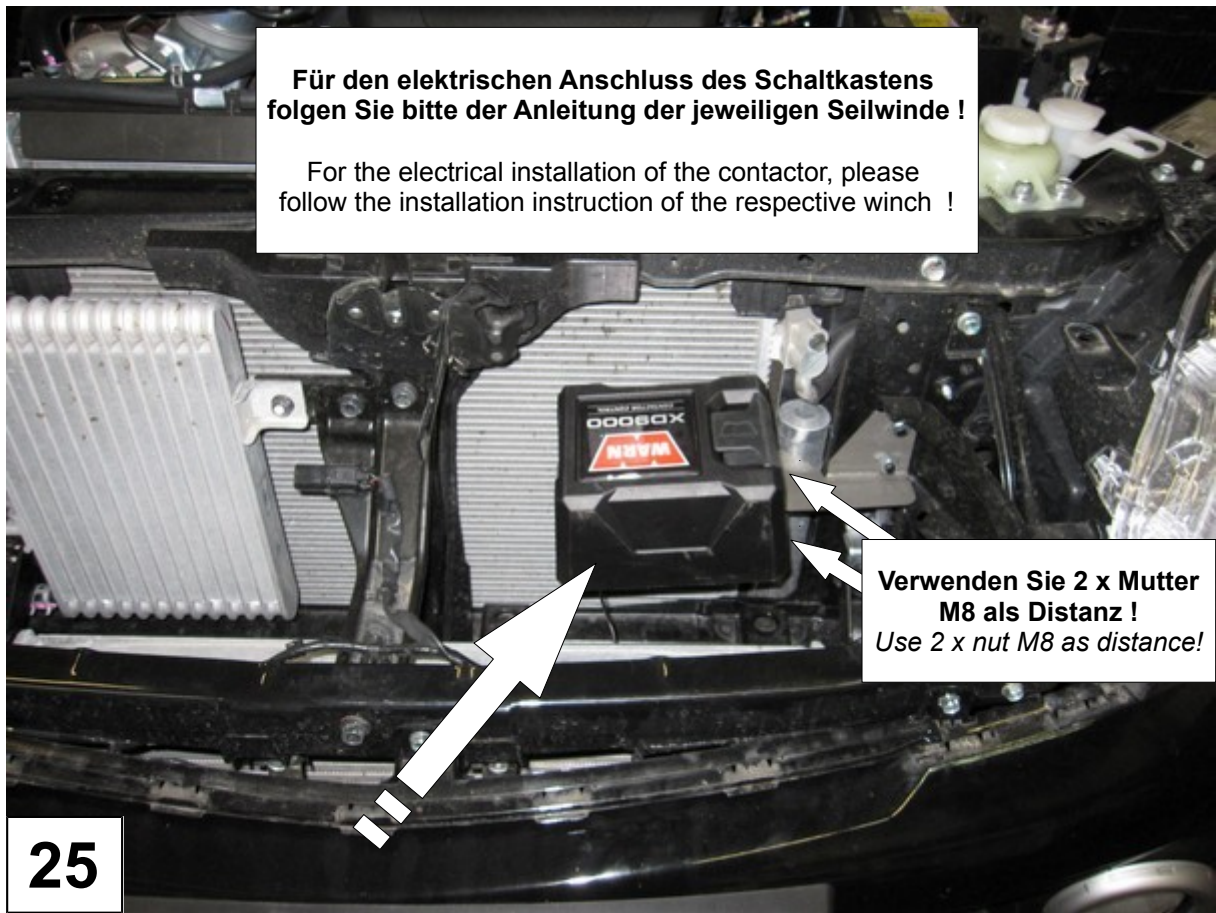

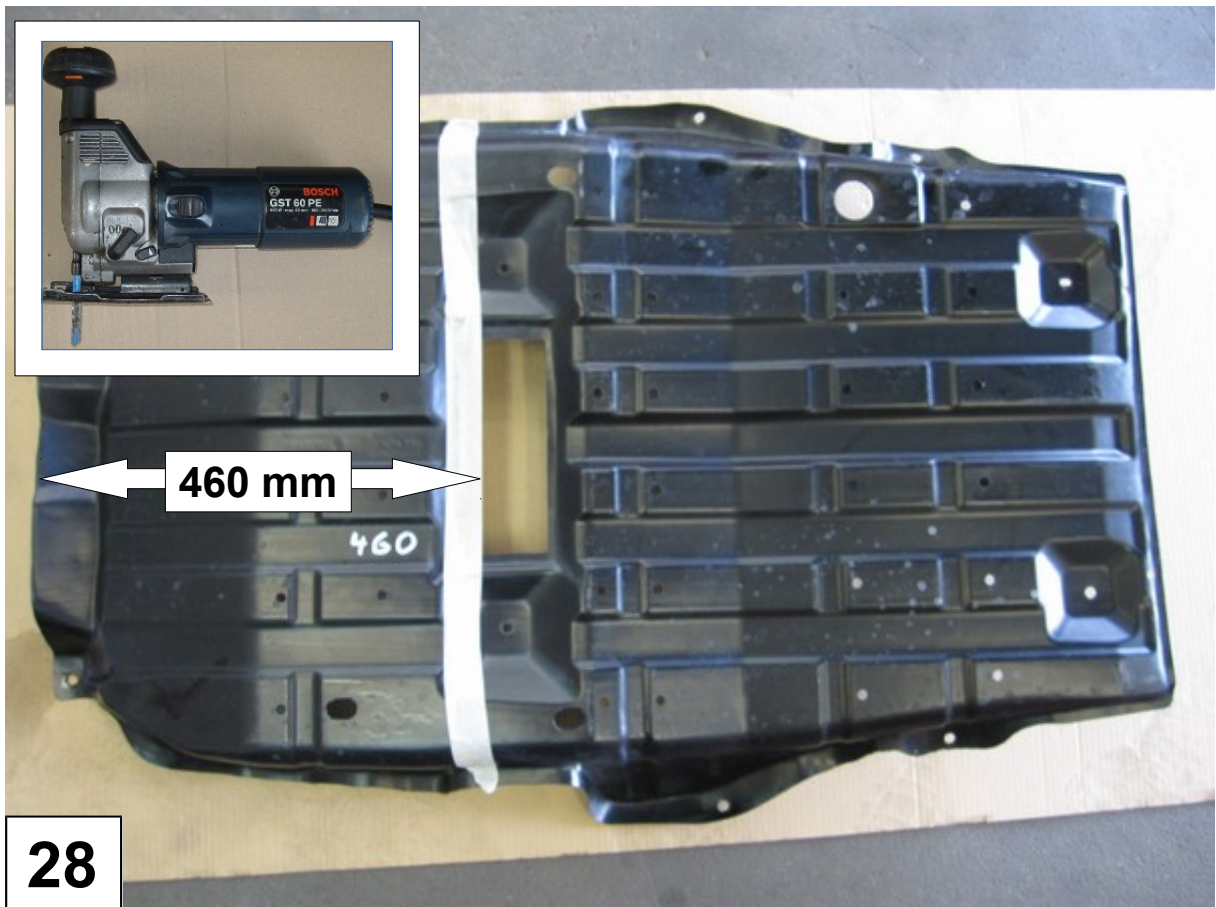
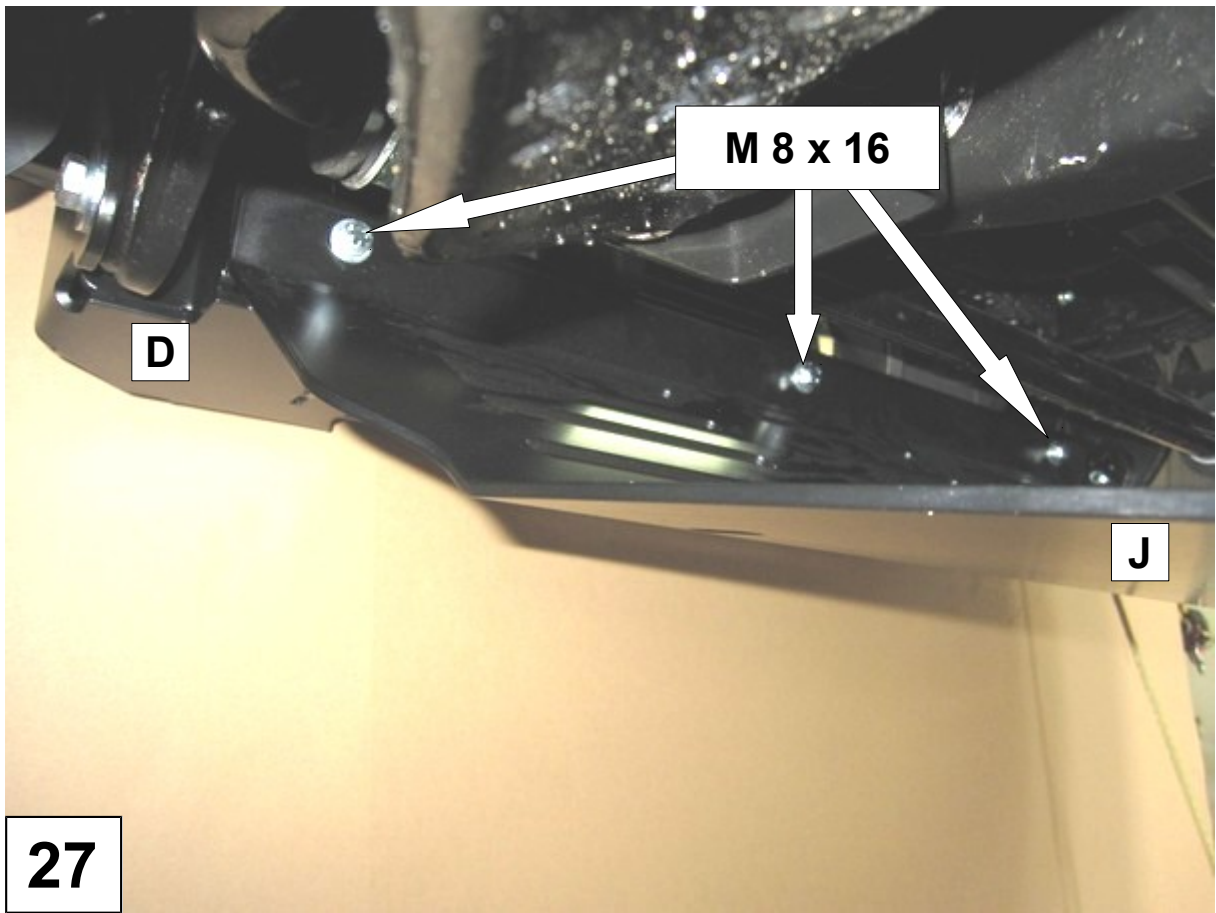

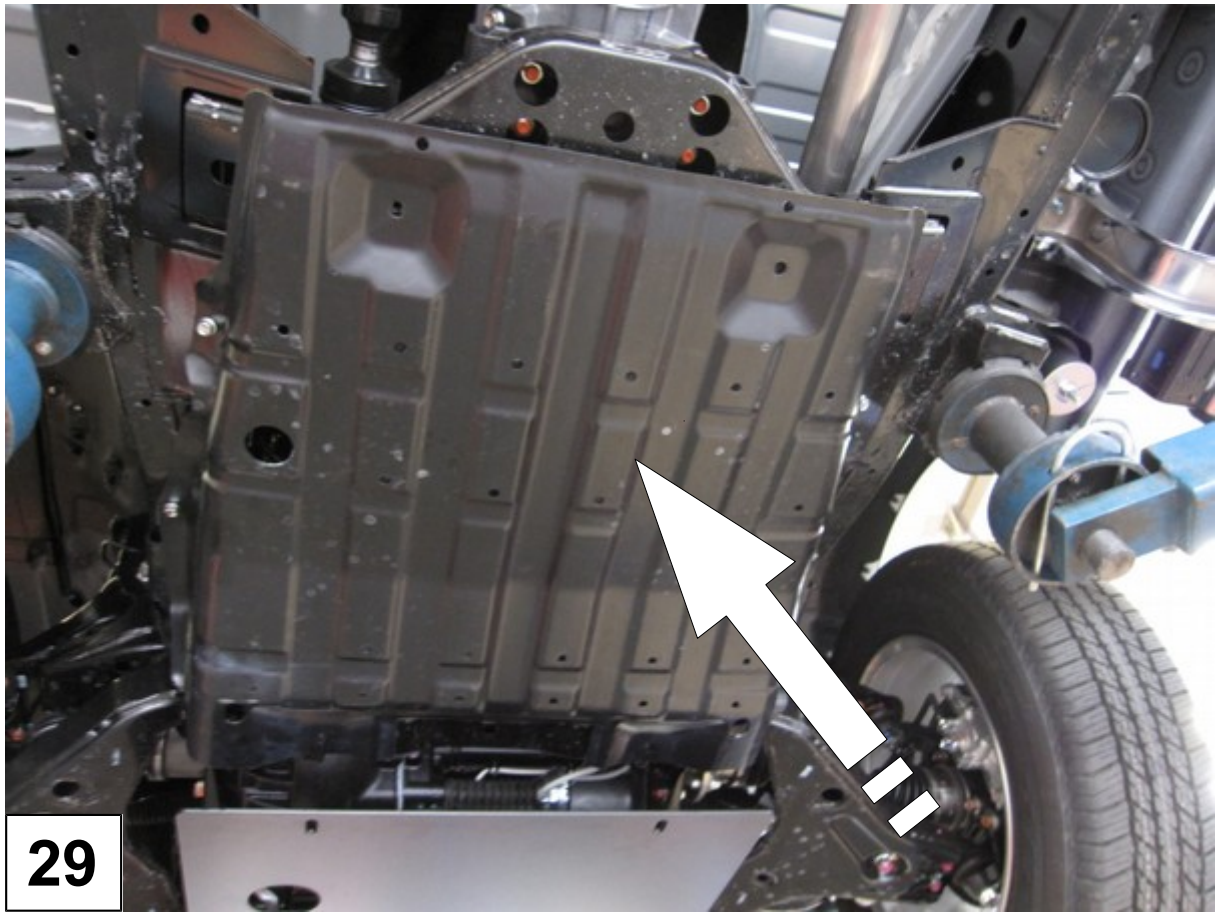

29

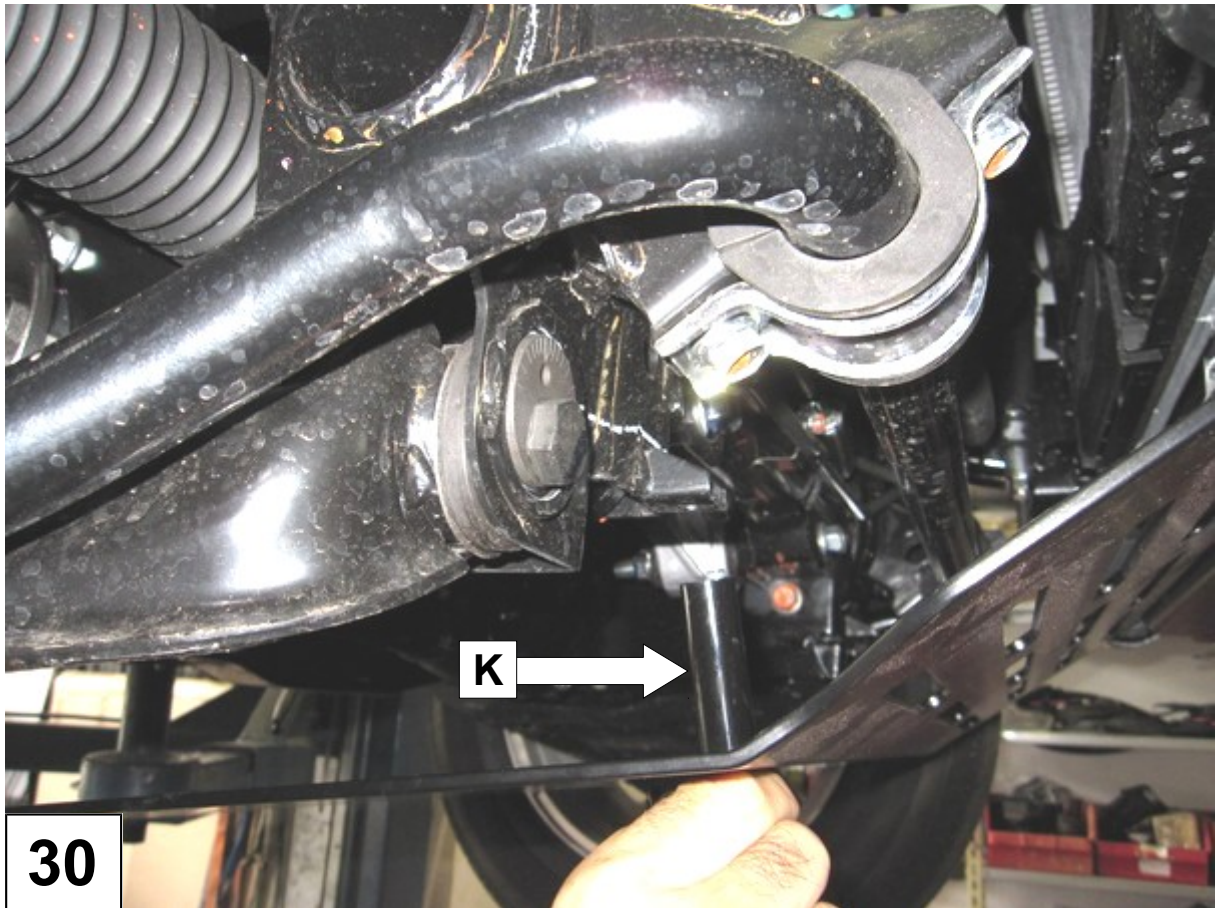

30

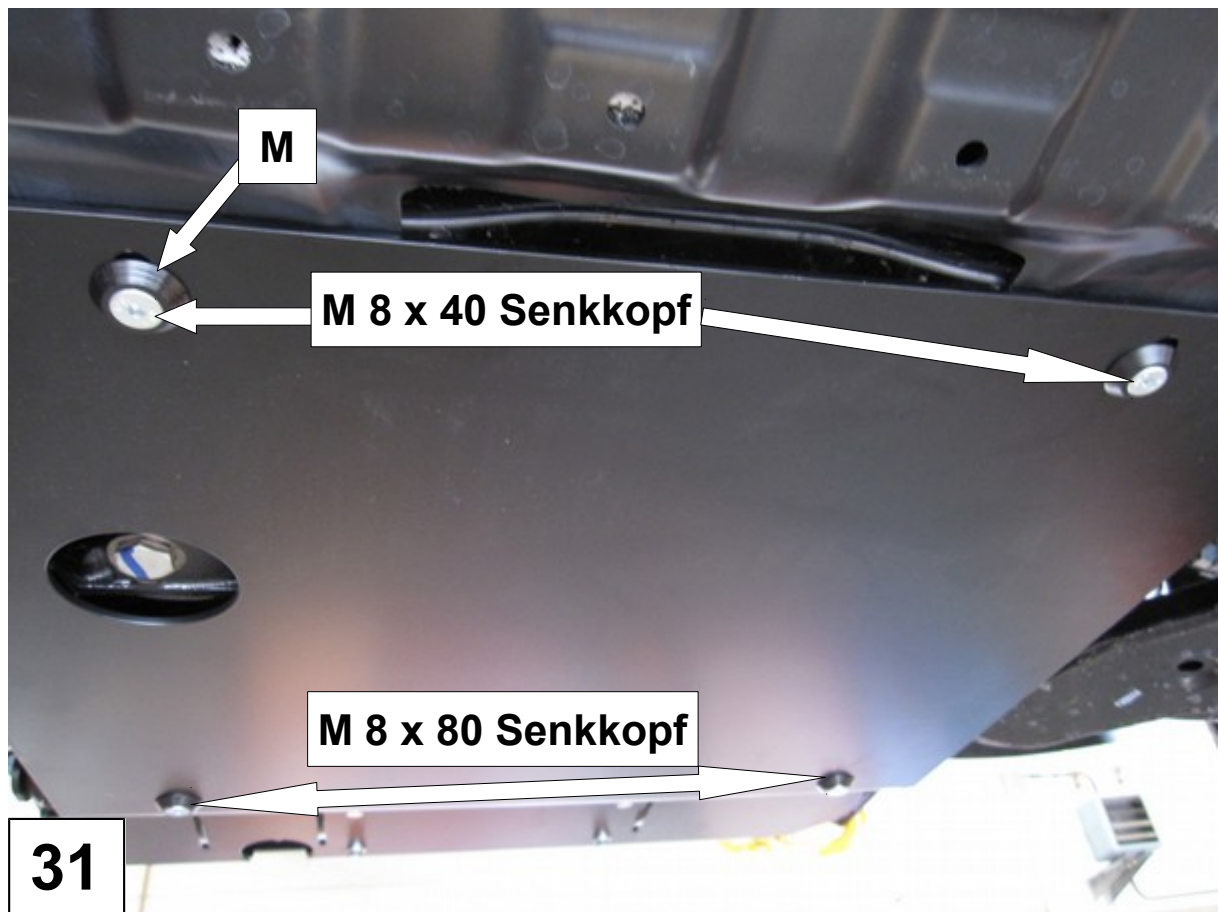

Achtung : Ziehen Sie jetzt alle Schrauben fest !
Attention: Tighten all screws now !



