

Anbauanleitung: Seilwindenanbausatz

AL: 2147-00

Best.Nr.: 16-6030

Montagezeit: ca. 8 Stunden

***Hier sehen sie den fertig montierten Seilwindenanbausatz.
Bevor sie mit der Montage beginnen, lesen sie bitte diese Anleitung und das
Benutzerhandbuch der Seilwinde gut durch.***

***Before you start fitting, please read and understand this instruction manual and the owners
manual of the winch.***



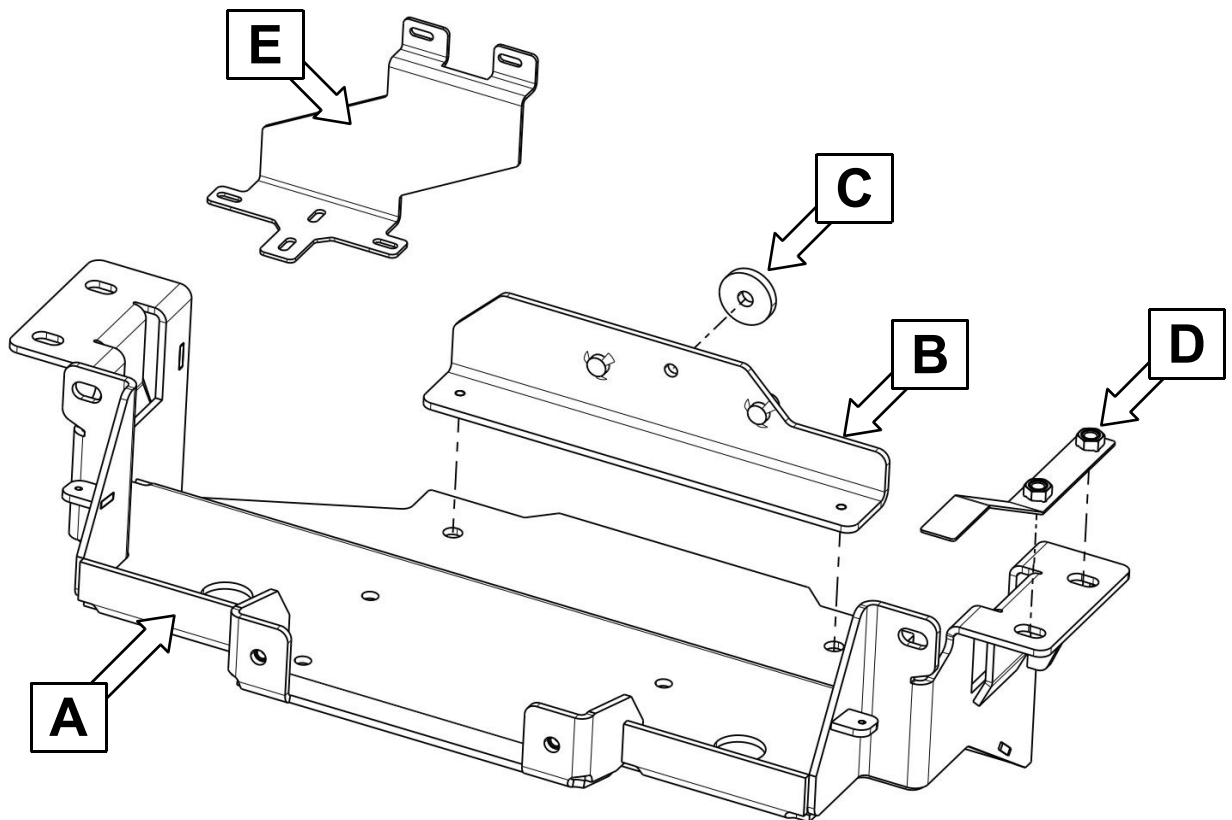

Stückliste

16-6030

Schraubensatz

1x 300mm Kabel 2,5² schwarz (A)
 1x Ringkabelschuh M8 blau
 1x Rundstecker blau
 1x Rundsteckhülse blau

1x Windenträger (B)
 1x Haltewinkel (C)
 1x Beilage (D)
 1x Befestigungsblech (E)
 1x Schaltkastenhalter (F)

1x 16-0512 Kühlerschutzblech (G)
 1x 16-0511 Freilaufhebel (H)
 1x 16-05070 Freilaufhebelverlängerung (I)
 600mm mit Gelenk

1x Anbauanleitung AL2147
 1x Gutachten+Aufkleber

1x Schraube M10 x 120
 2x Scheibe M10
 1x Federring M10
 1x Mutter M10

2x Schraube M12 x 1,25 x 50
 2x Schraube M12 x 35
 4x Scheibe M12
 4x Federring M12

2x Senkscheibe M8 Alu
 2x Senkschraube M8 x 25

4x Schraube M6 x 20
 6x Scheibe M6
 4x Federring M6
 2x Mutter M6

2x Schraube M5 x 12
 4x Scheibe M5
 2x Federring M5
 2x Mutter M5

Schrauben Anzugsmomente siehe letzte Seite!
Torque information see last page!

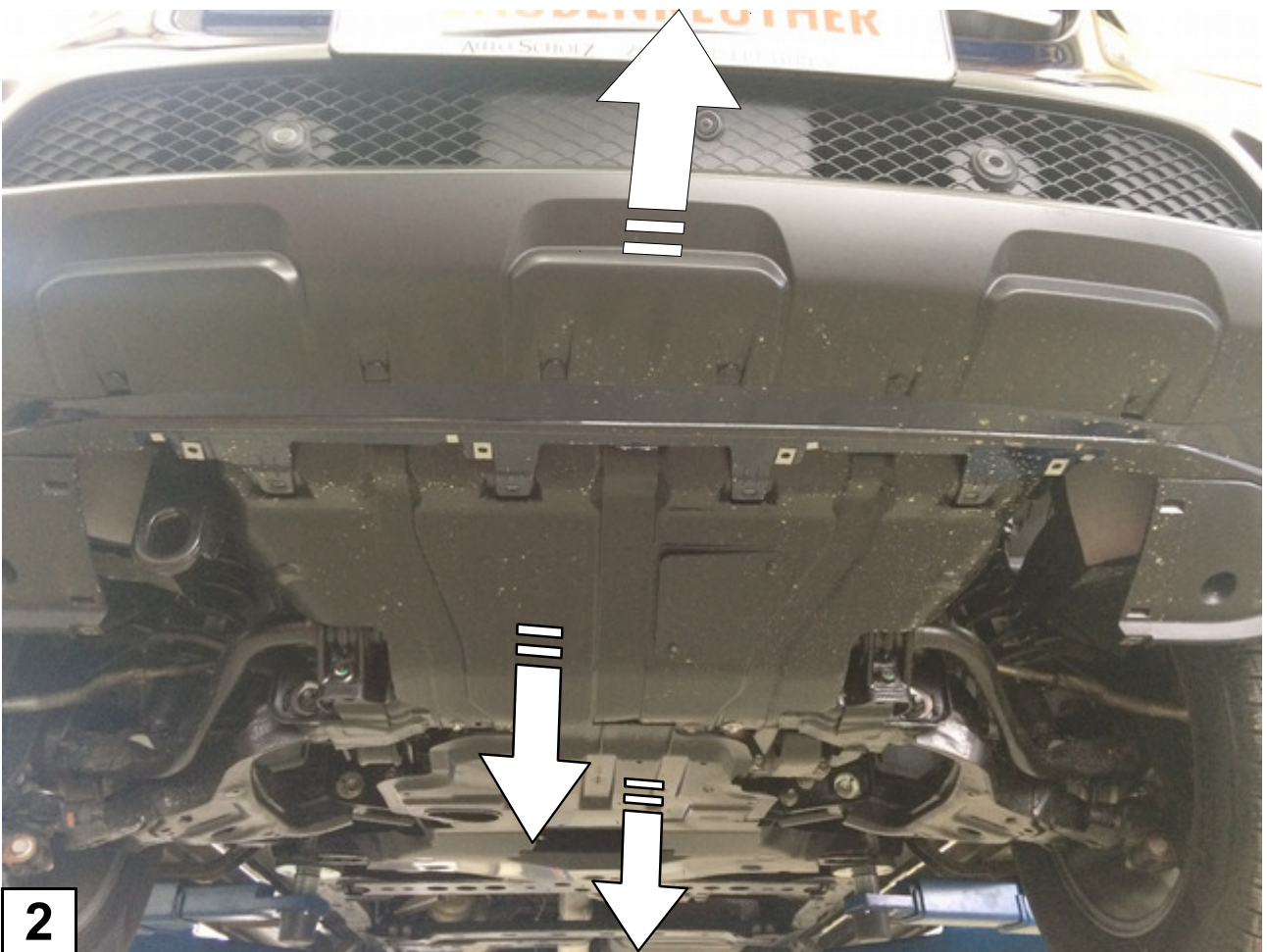

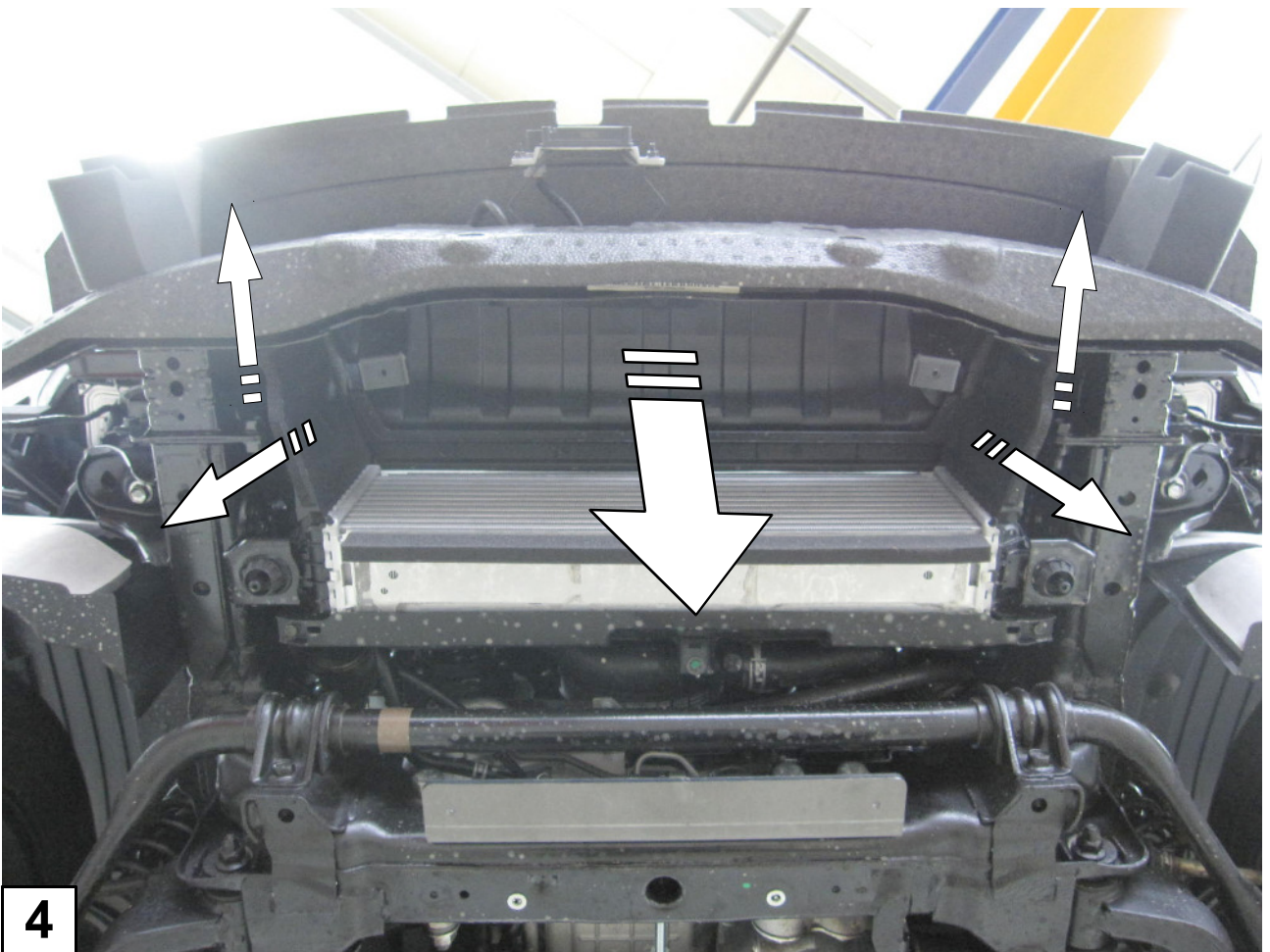

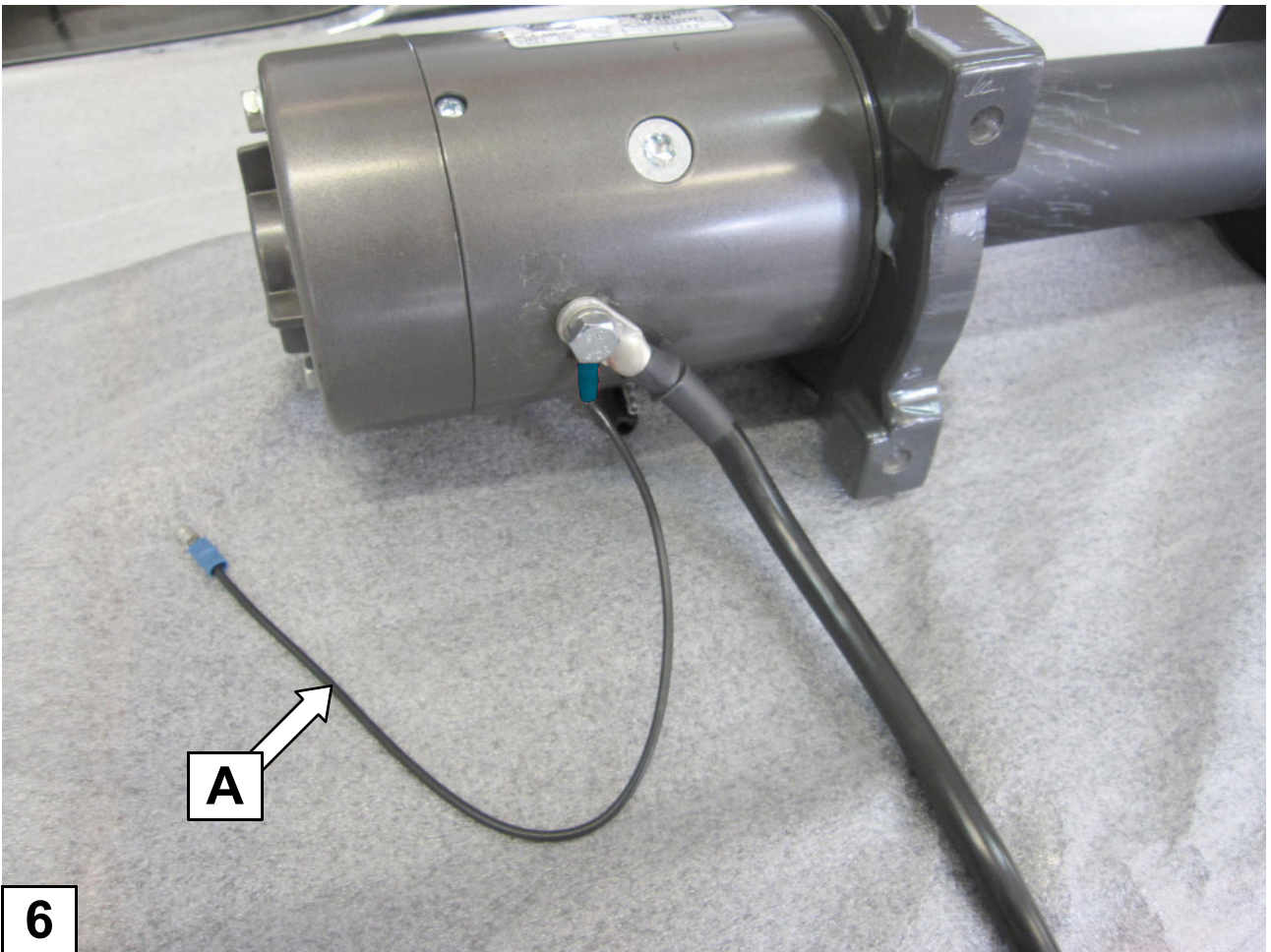
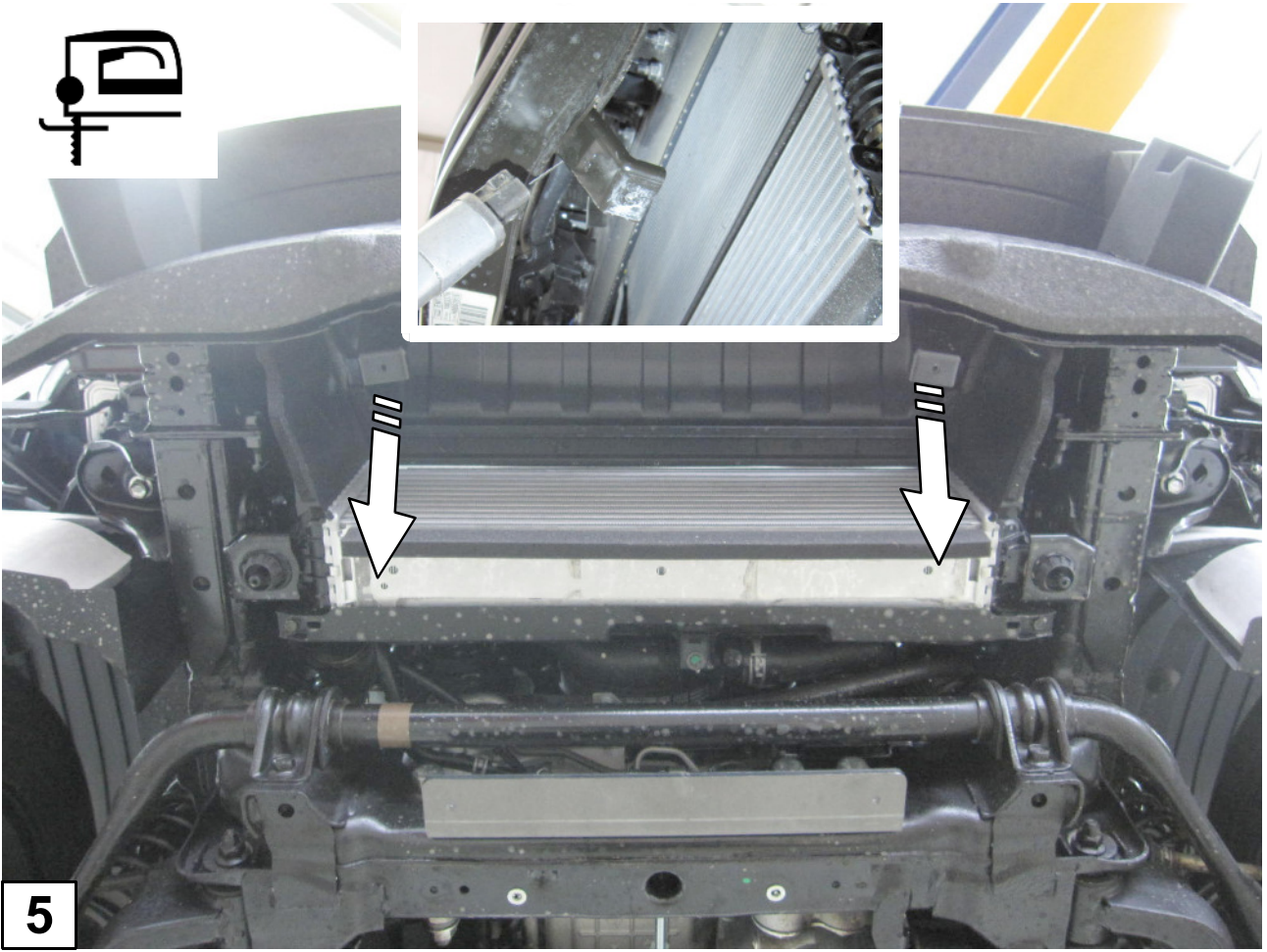



**Einbauanleitung der Seilwinde
beachten!**

*Please follow installation manual of the
winch!*

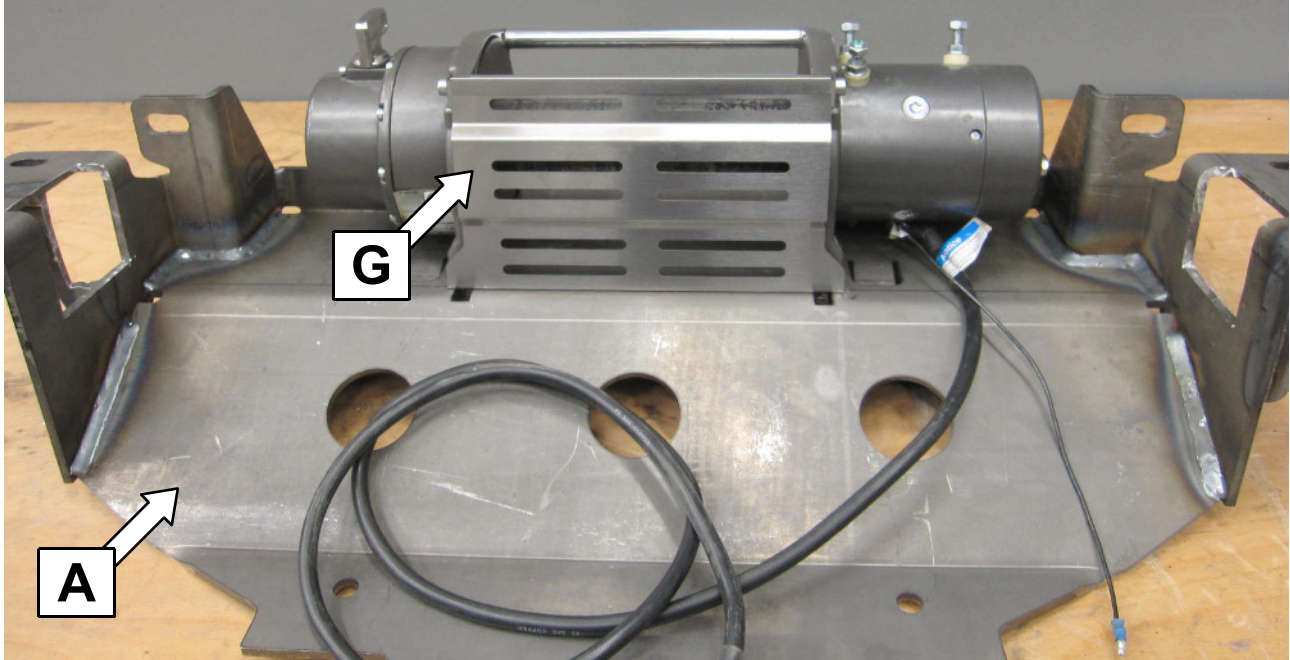

7

Einbauanleitung 16-0512 beachten! / Observe manuel 16-0512!

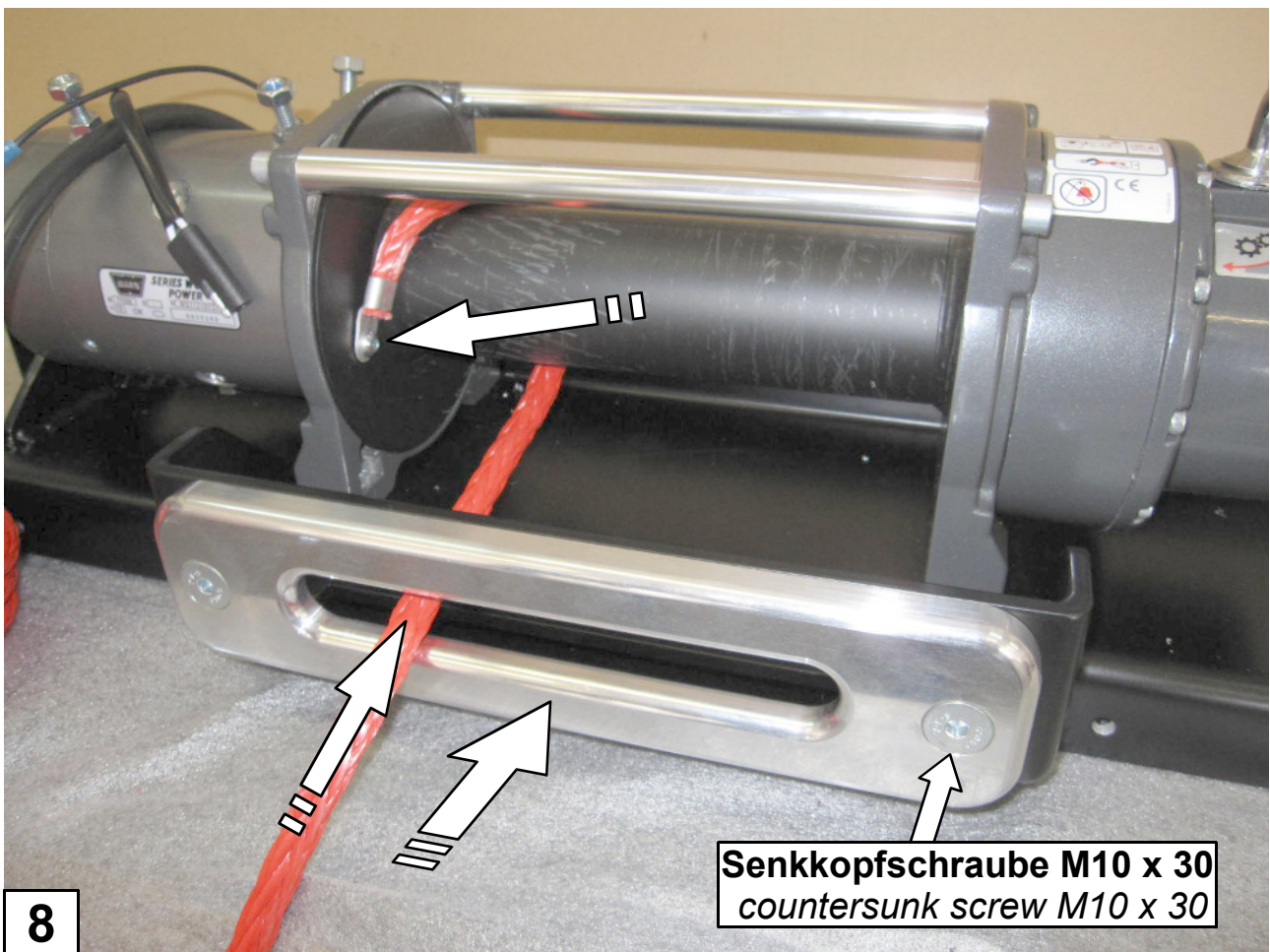

8

**Senkkopfschraube M10 x 30
countersunk screw M10 x 30**

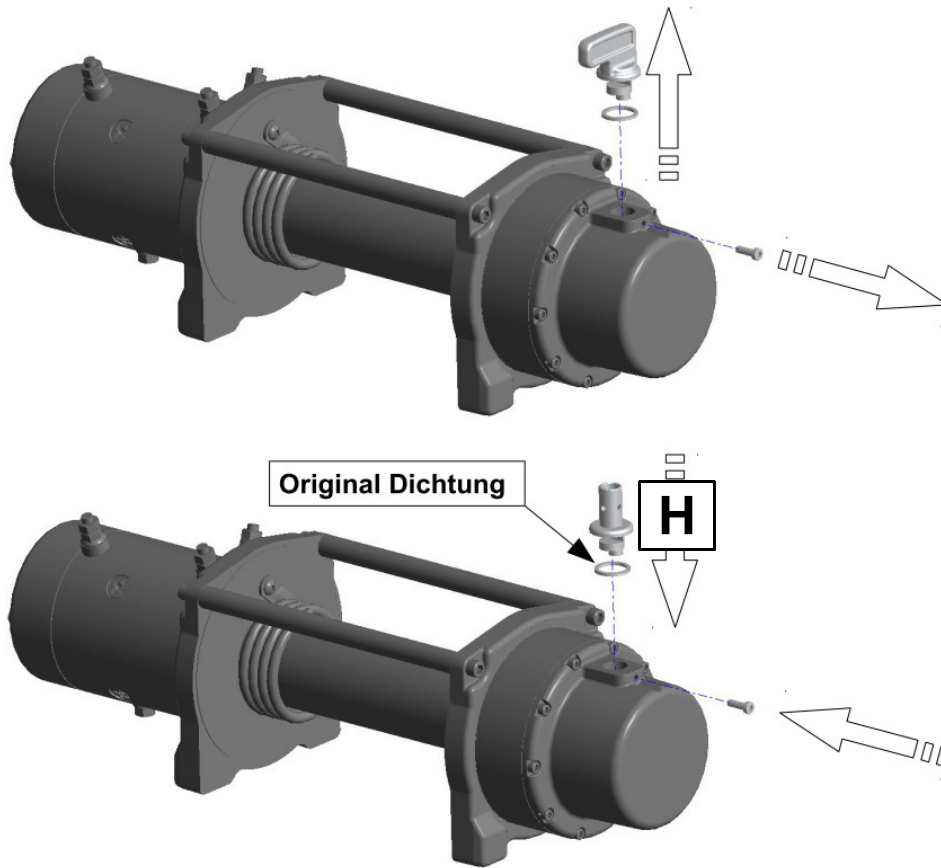

9

Einbauanleitung 16-0511 beachten! / Observe manuel 16-0511!

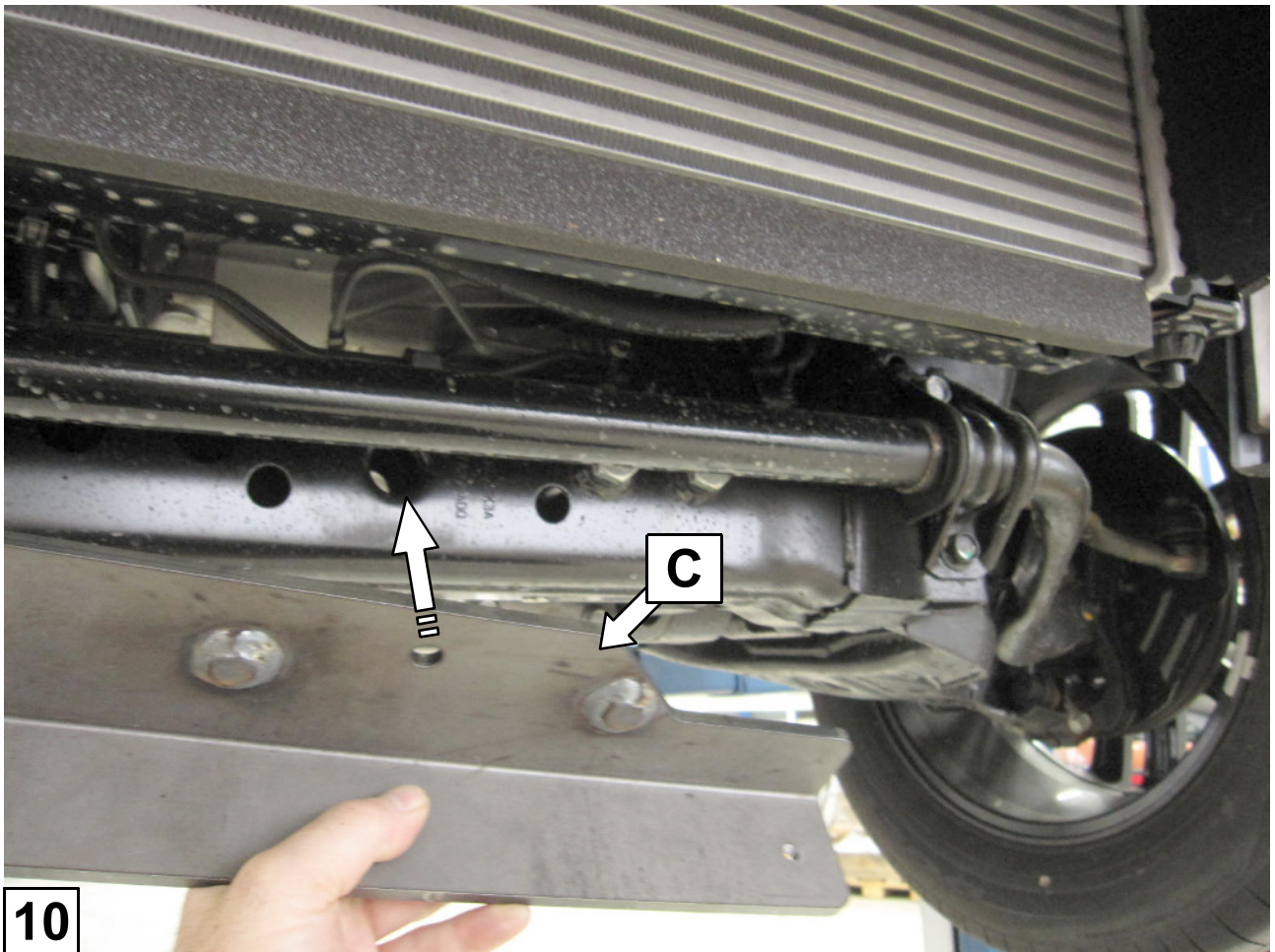

10

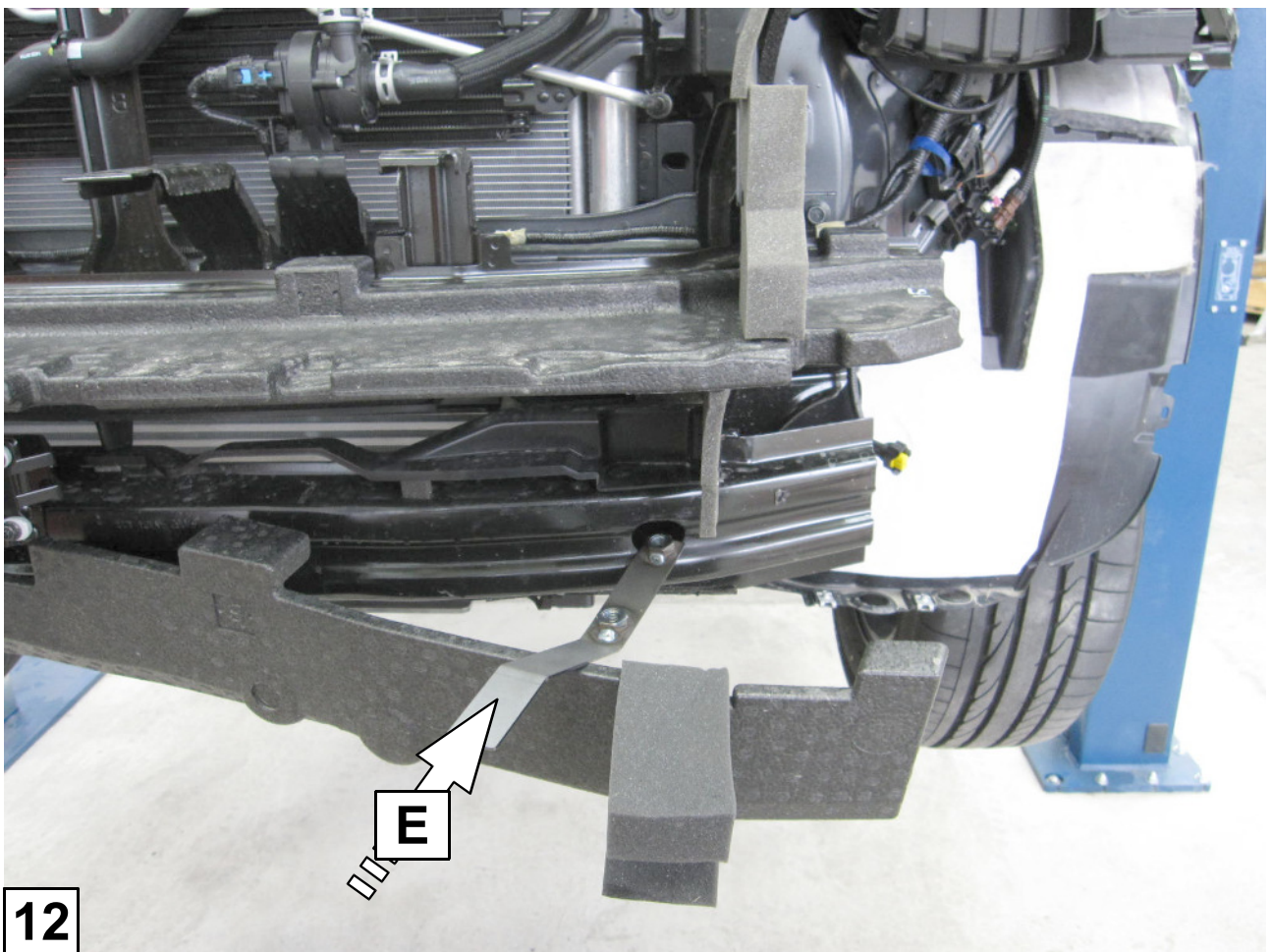
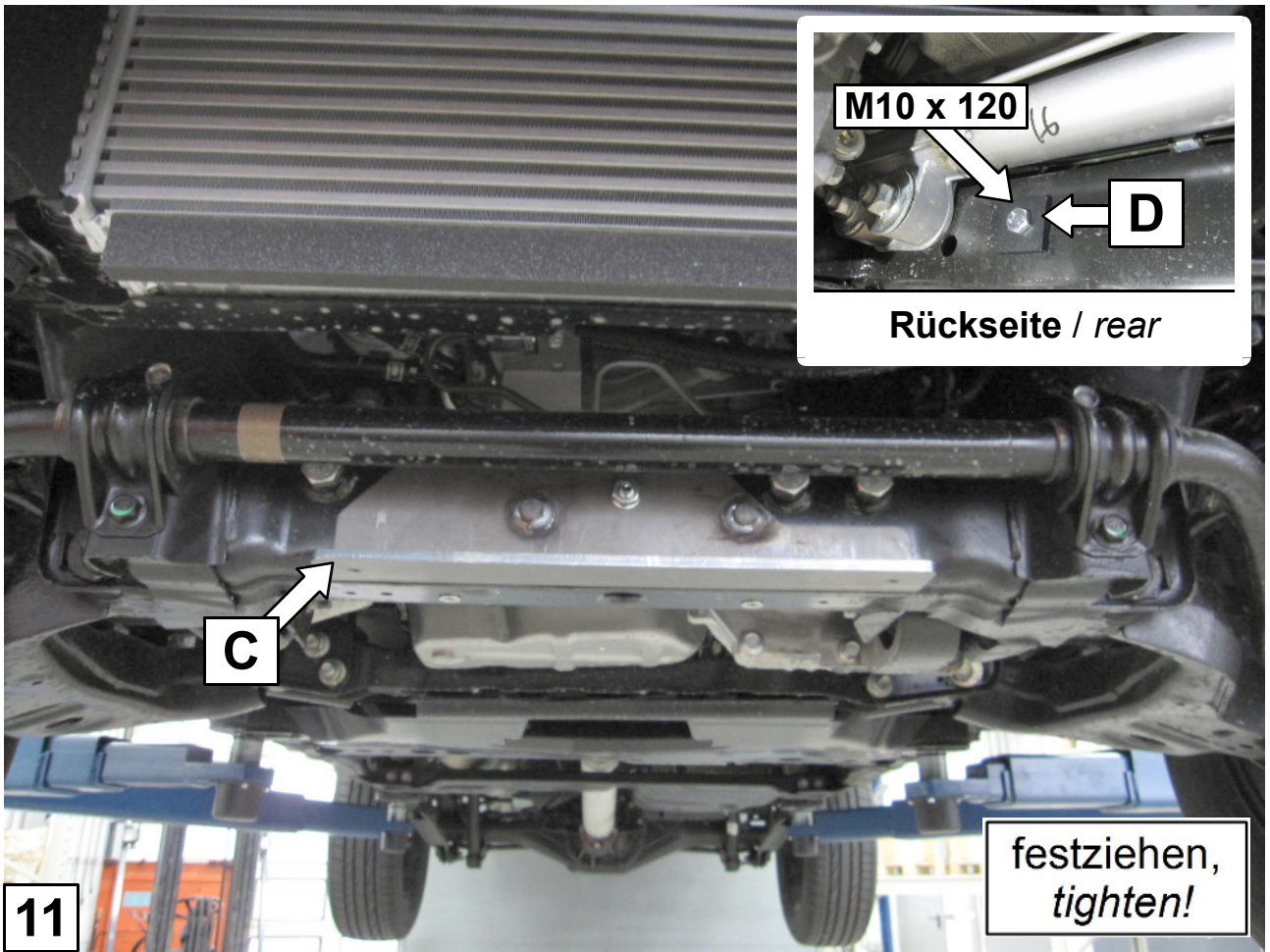

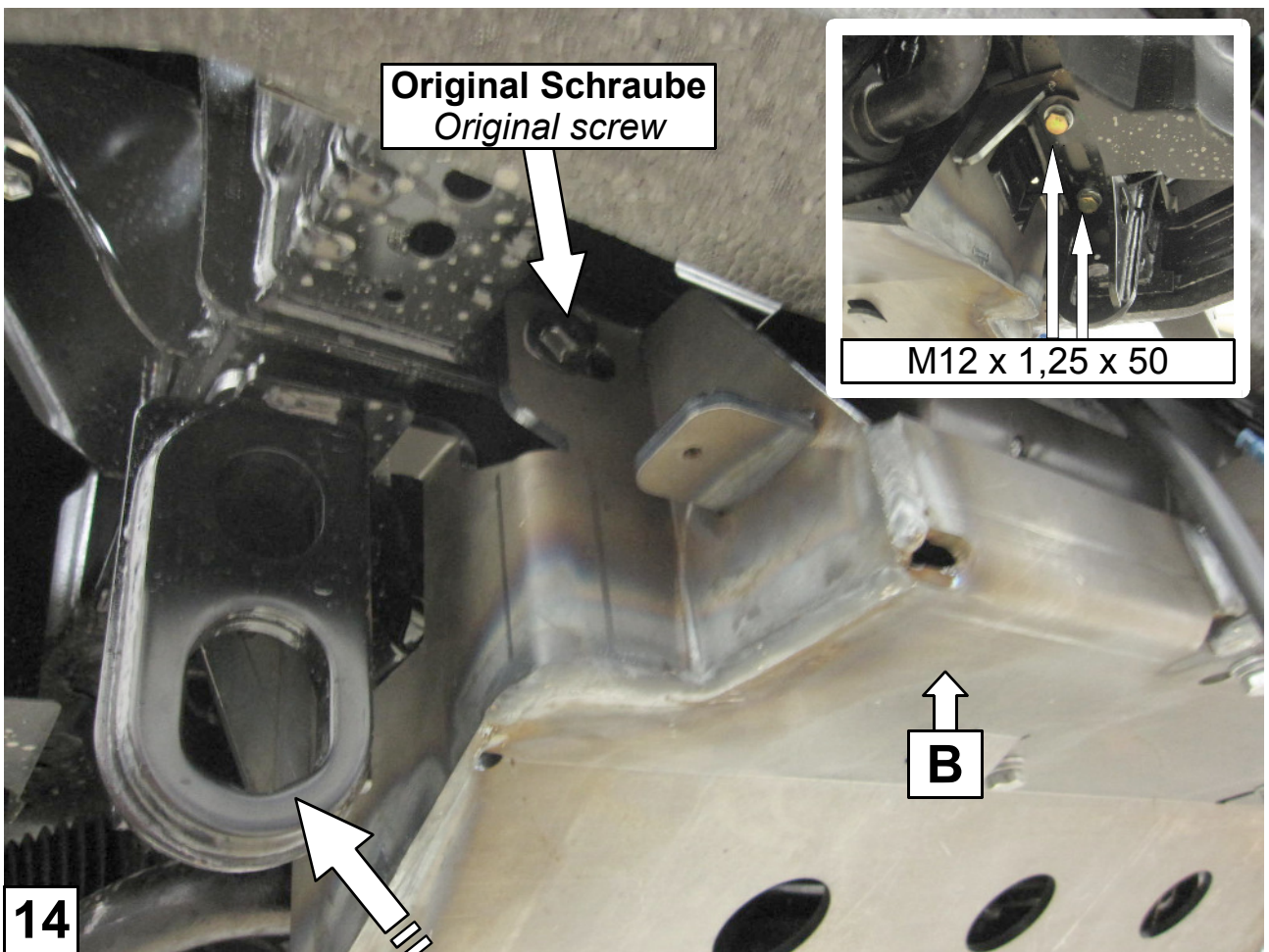
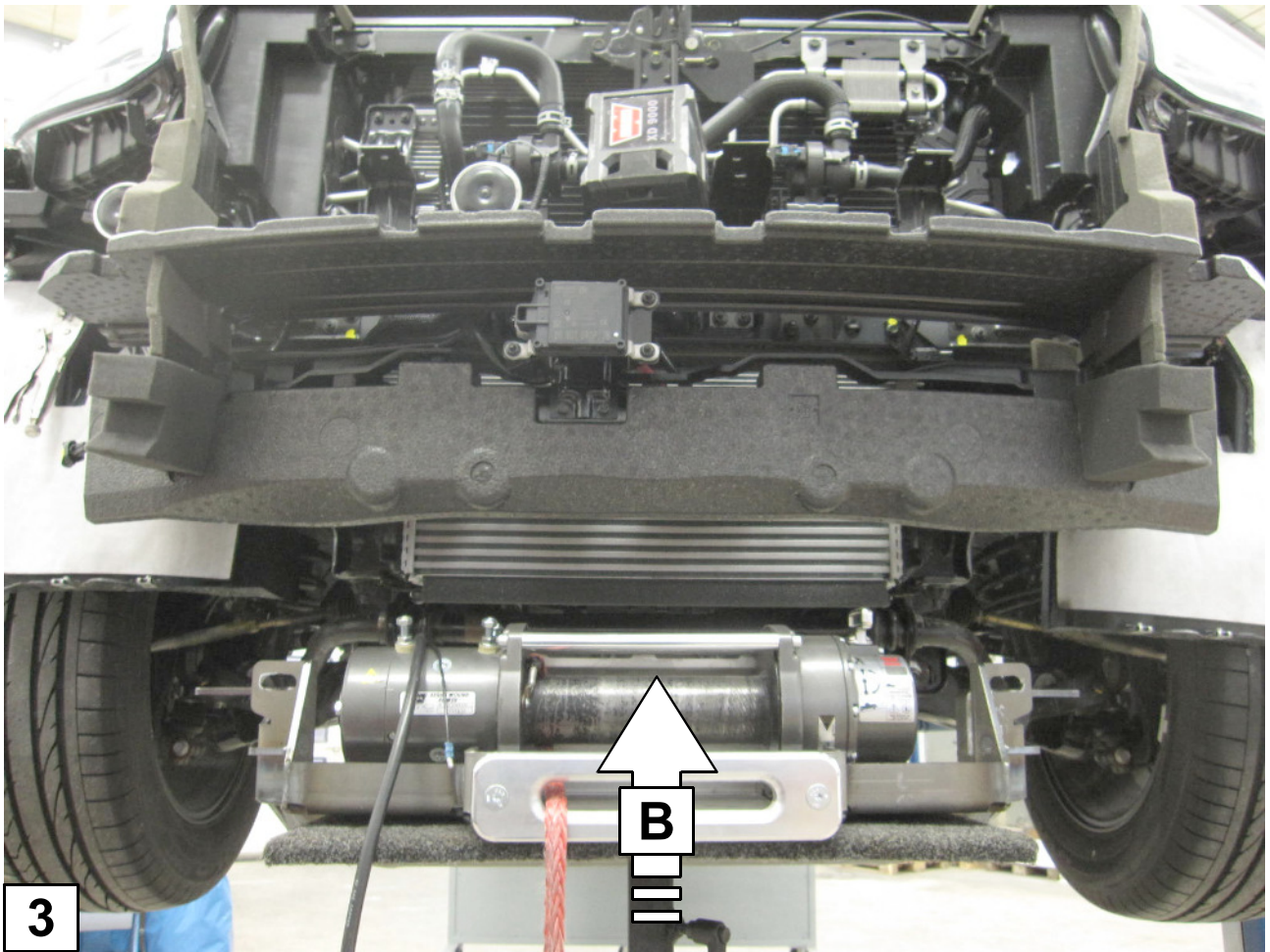

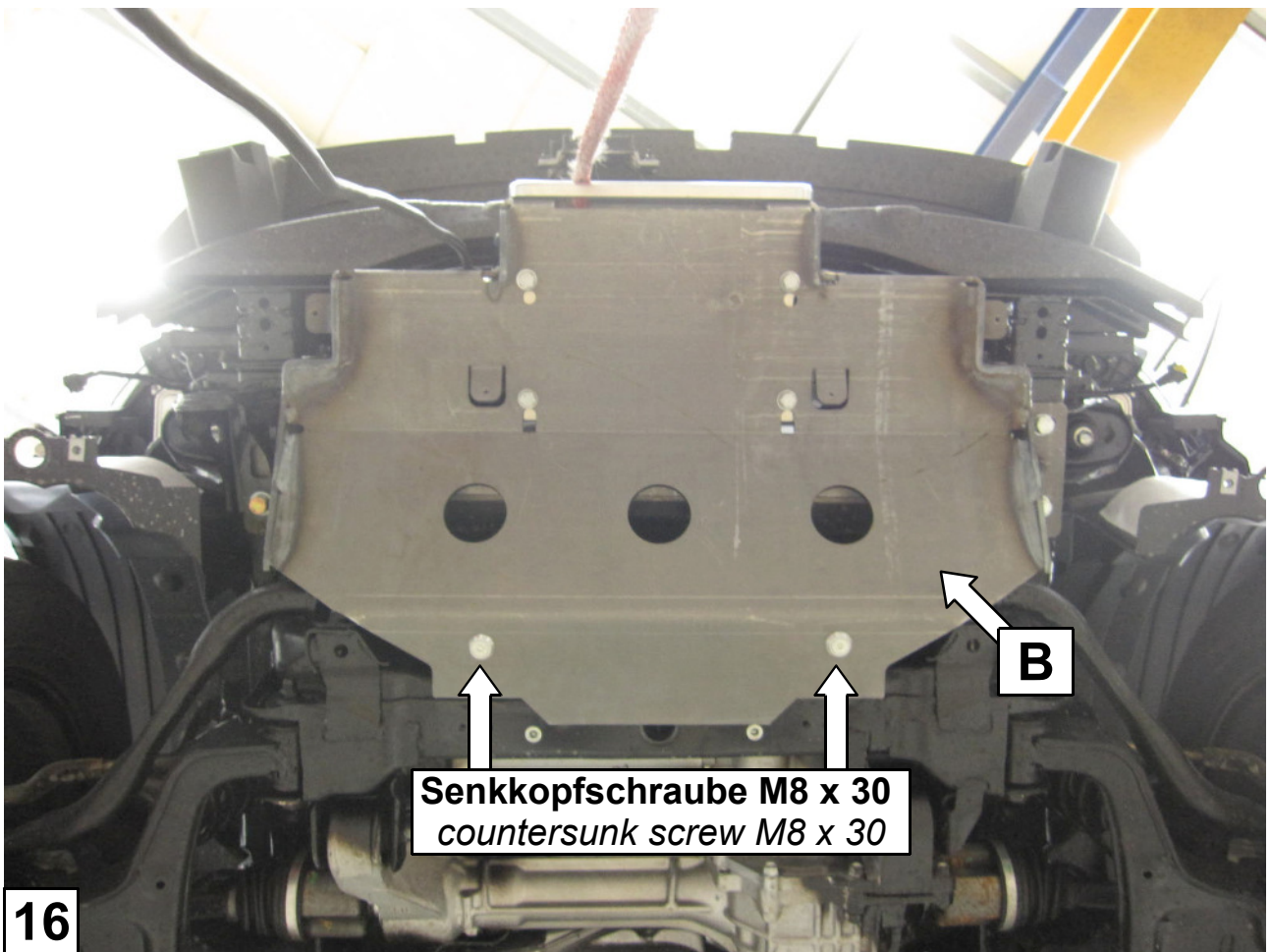
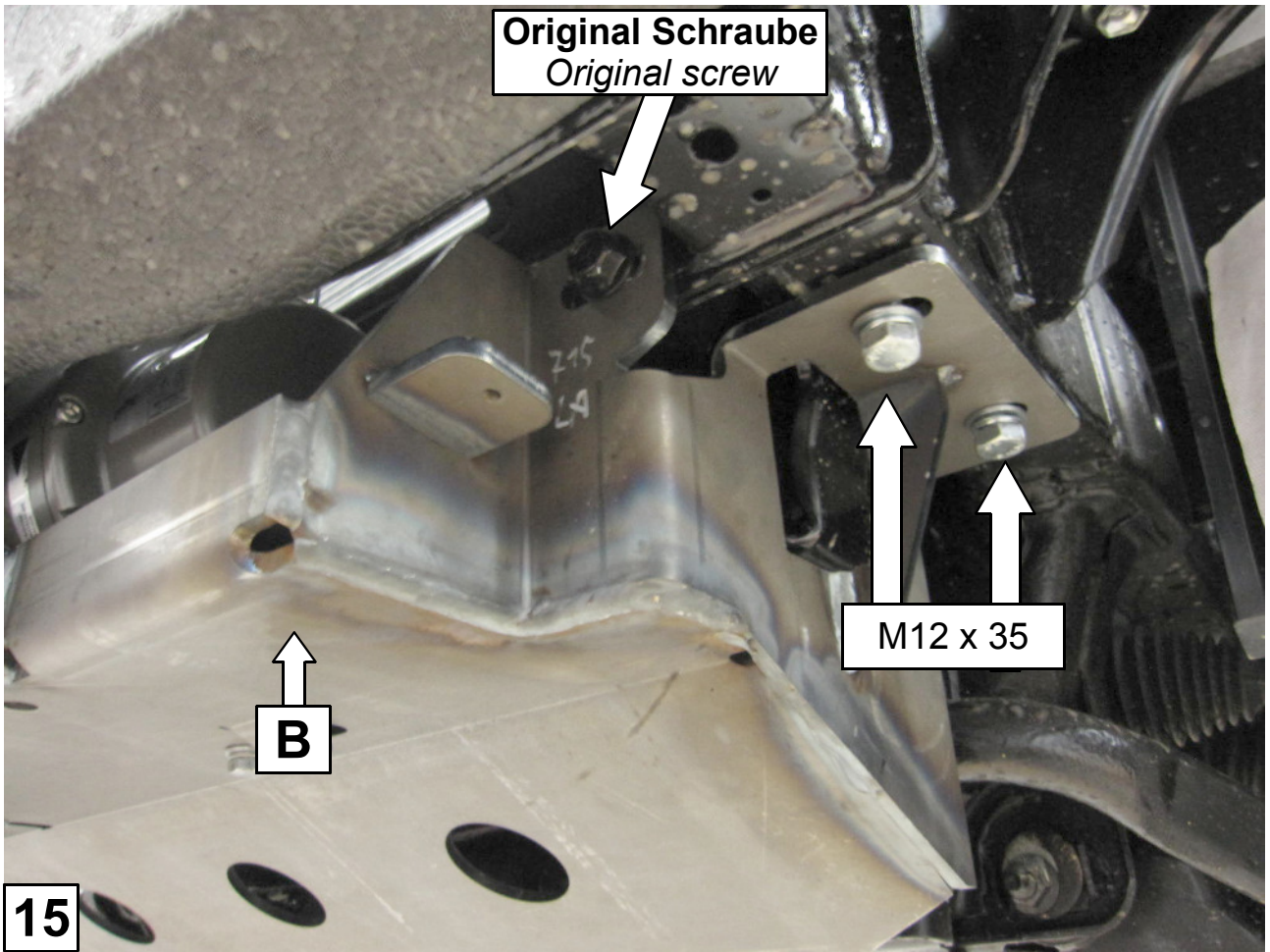

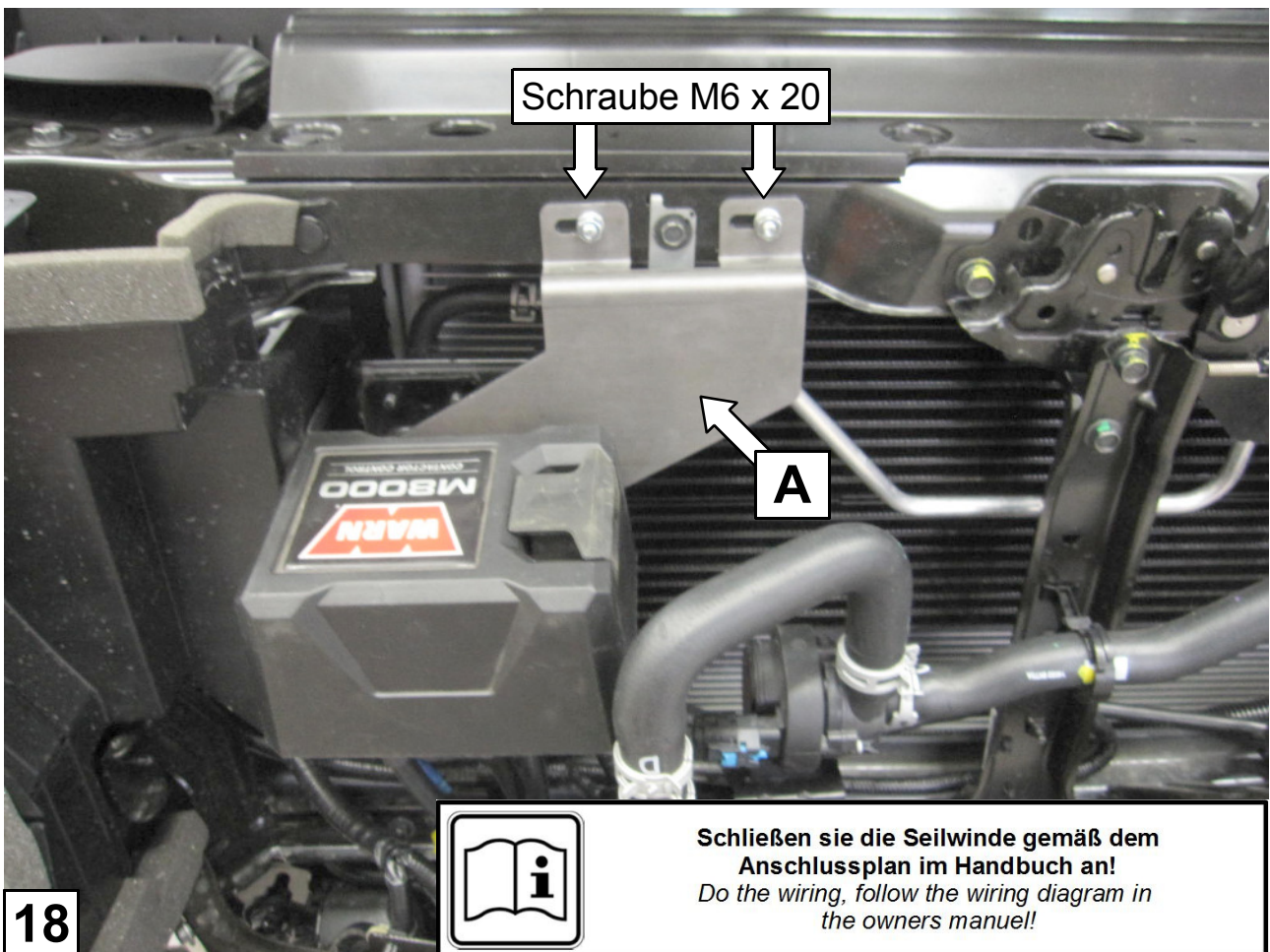
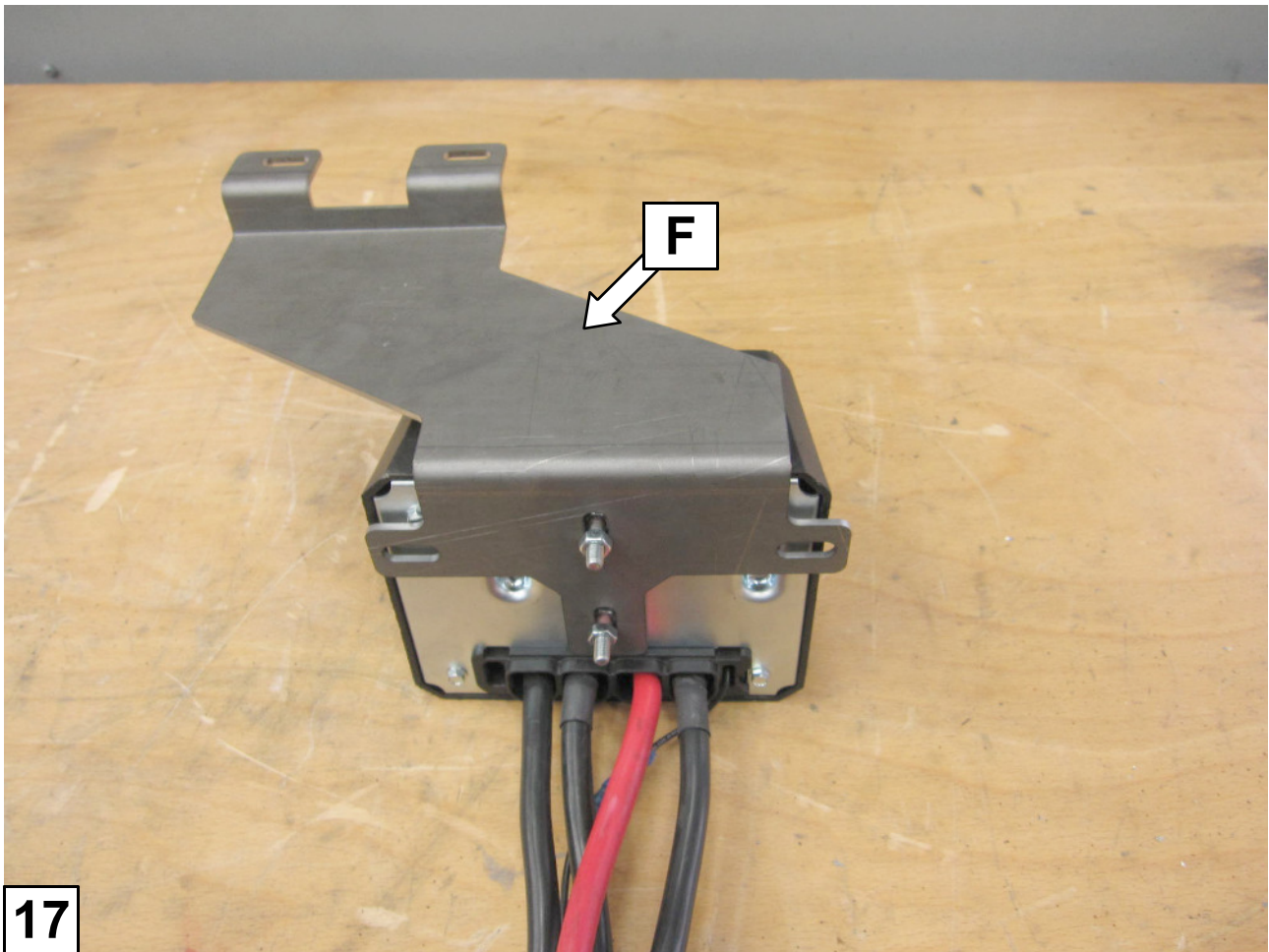

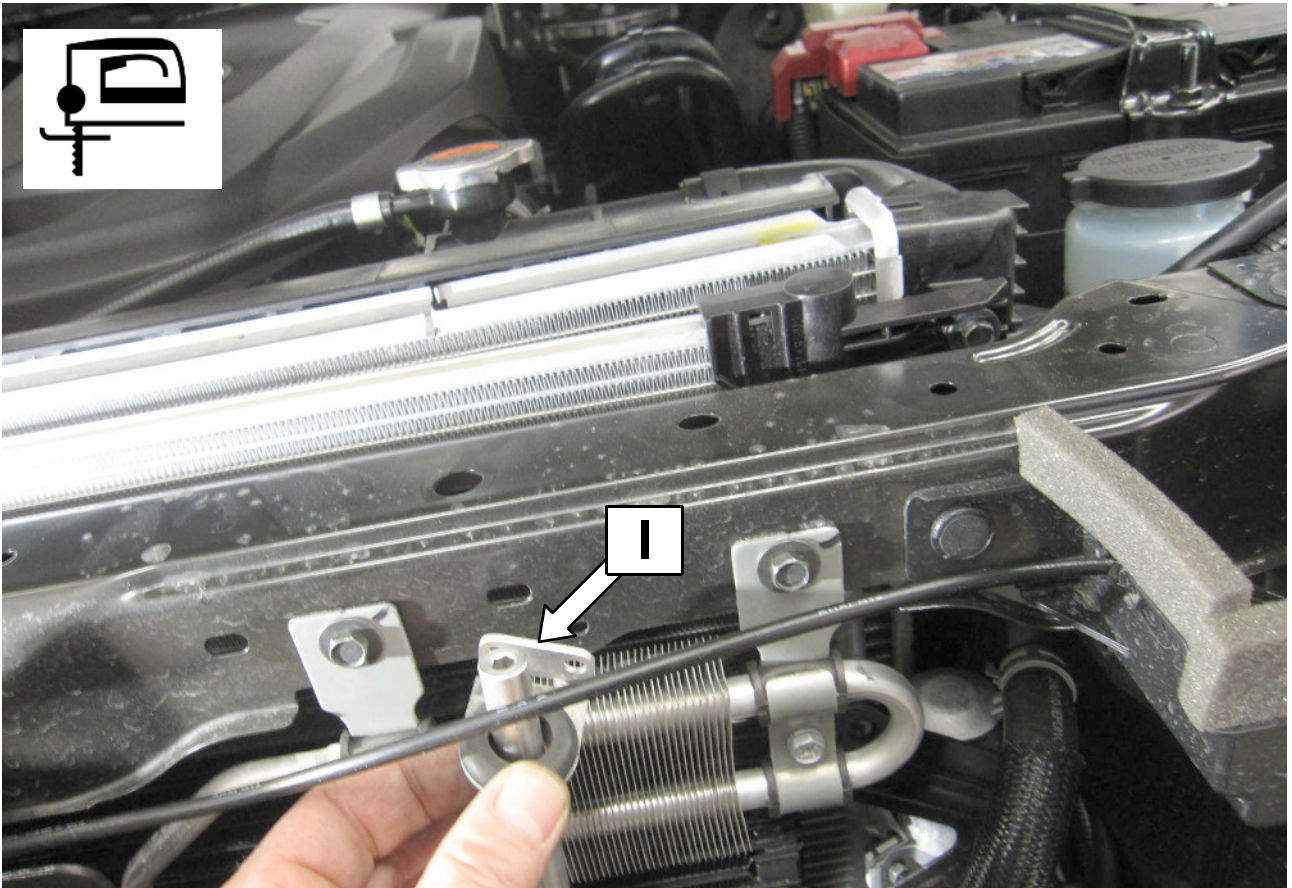

19

Einbauanleitung 16-05070 beachten, Stange auf 550mm kürzen
Observe manuel 16-05070, cut the extension rod to 550mm!

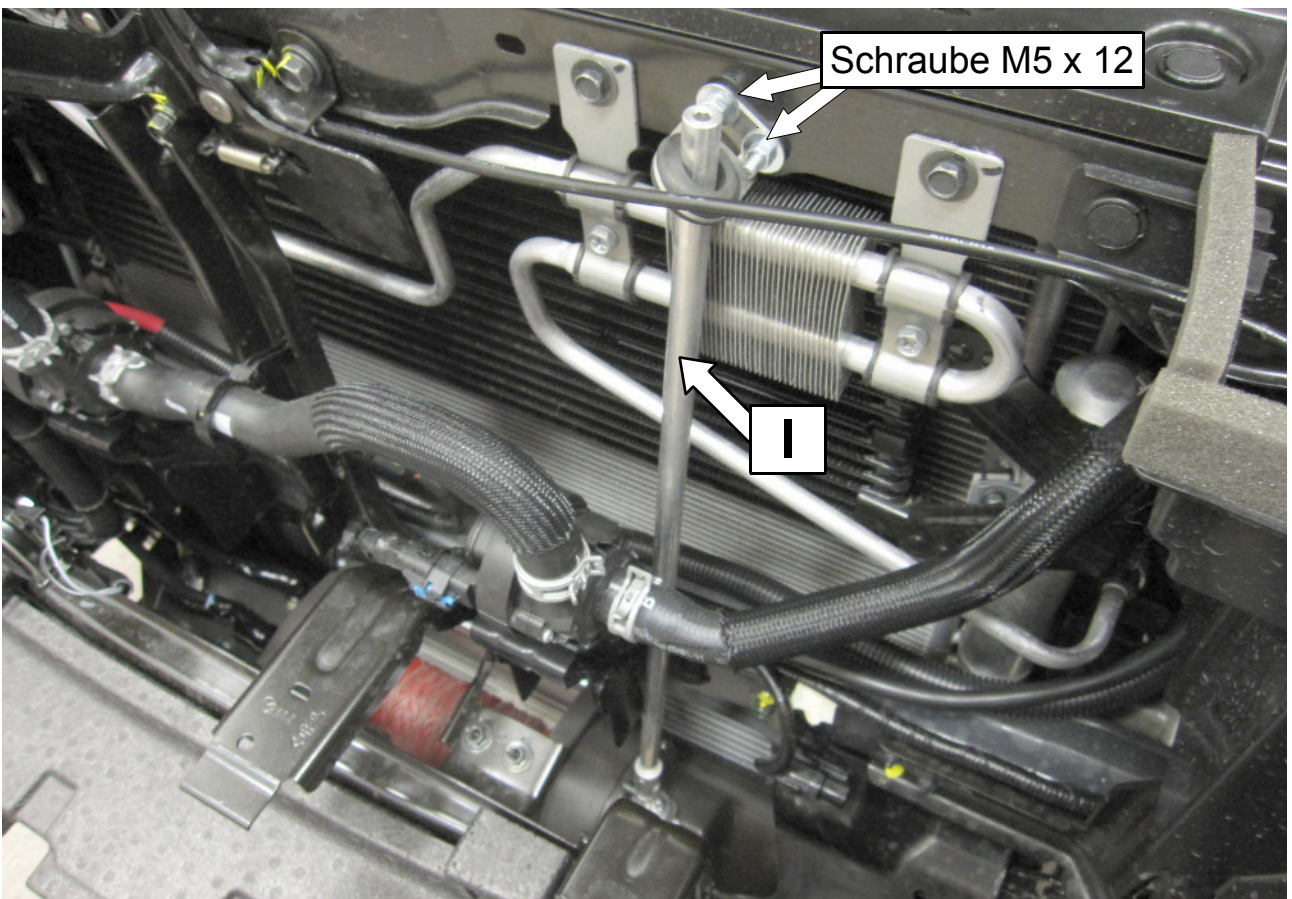

20

Einbauanleitung 16-05070 beachten / *Observe manuel 16-05070*

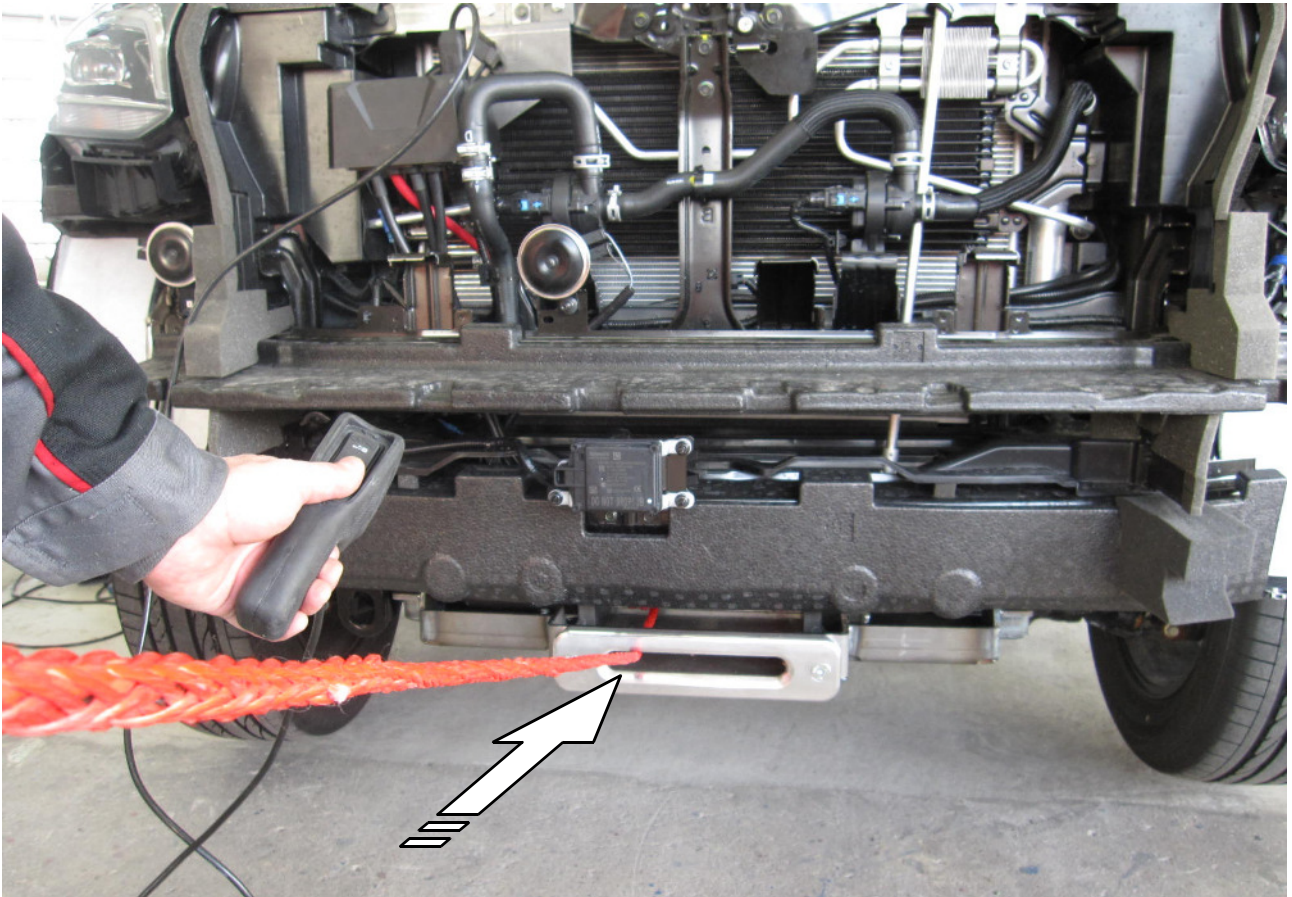

21

Seil aufspulen! / *spool in the rope!*

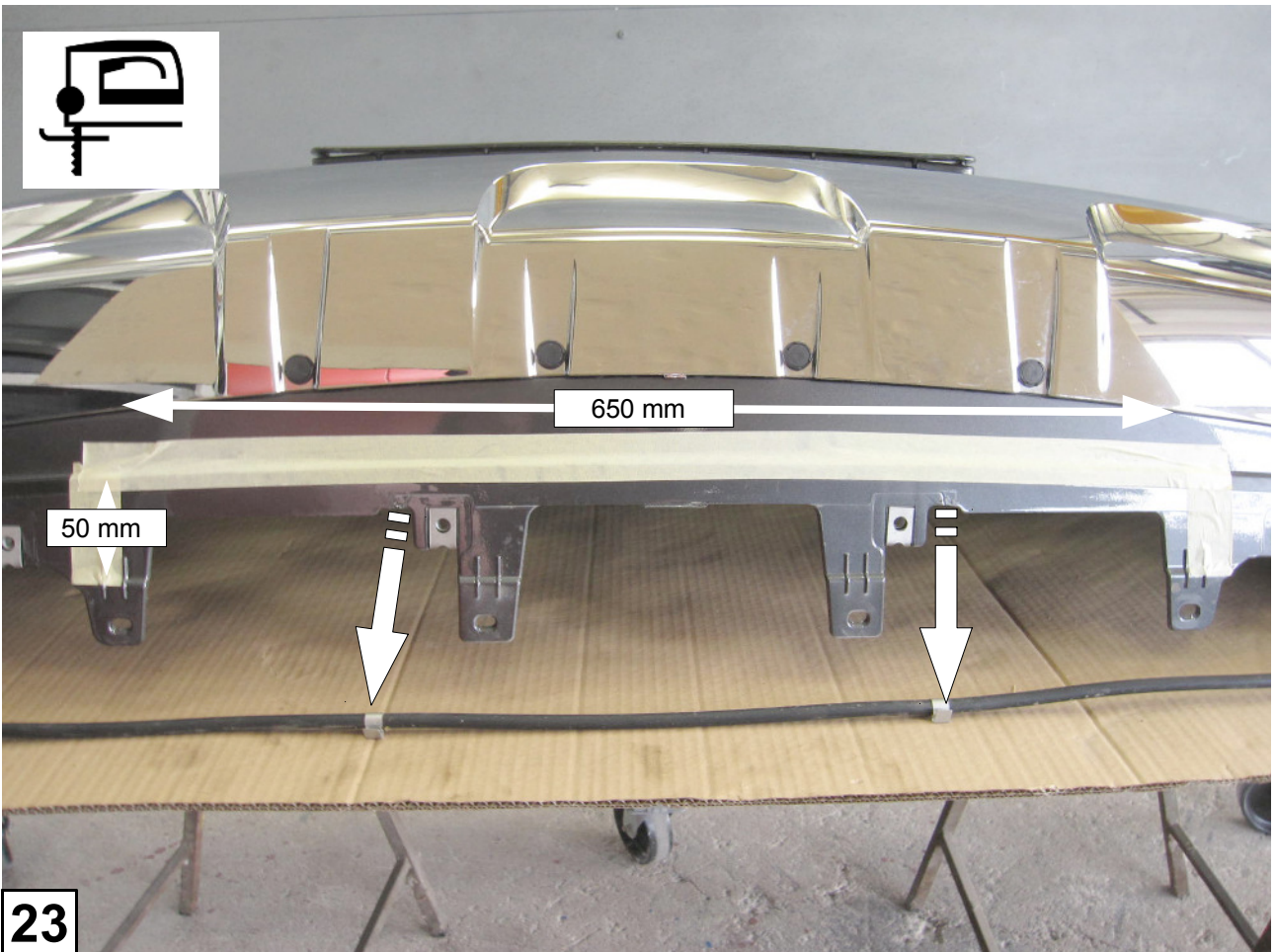

23

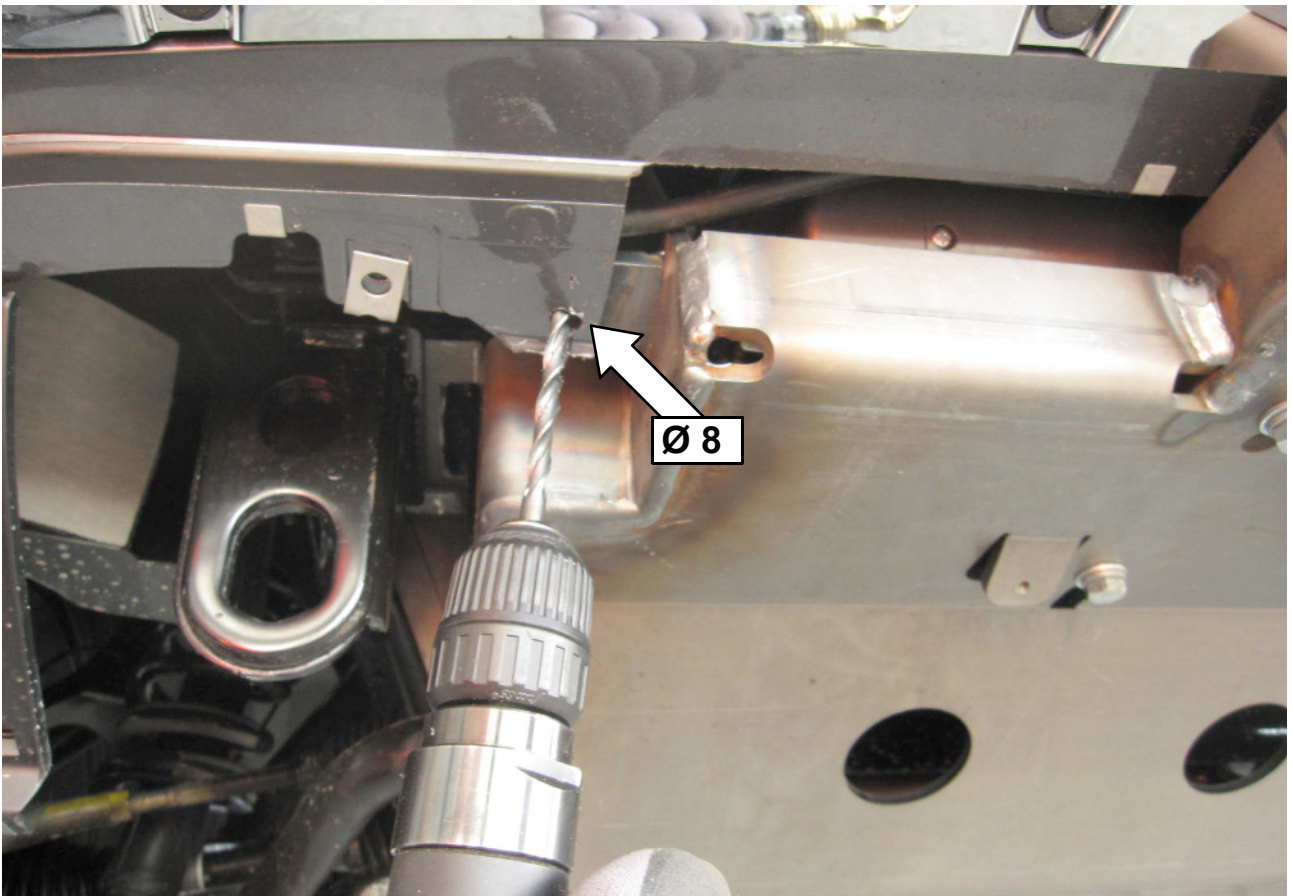

25 Das Gleiche an der linken Seite / the same on the left side

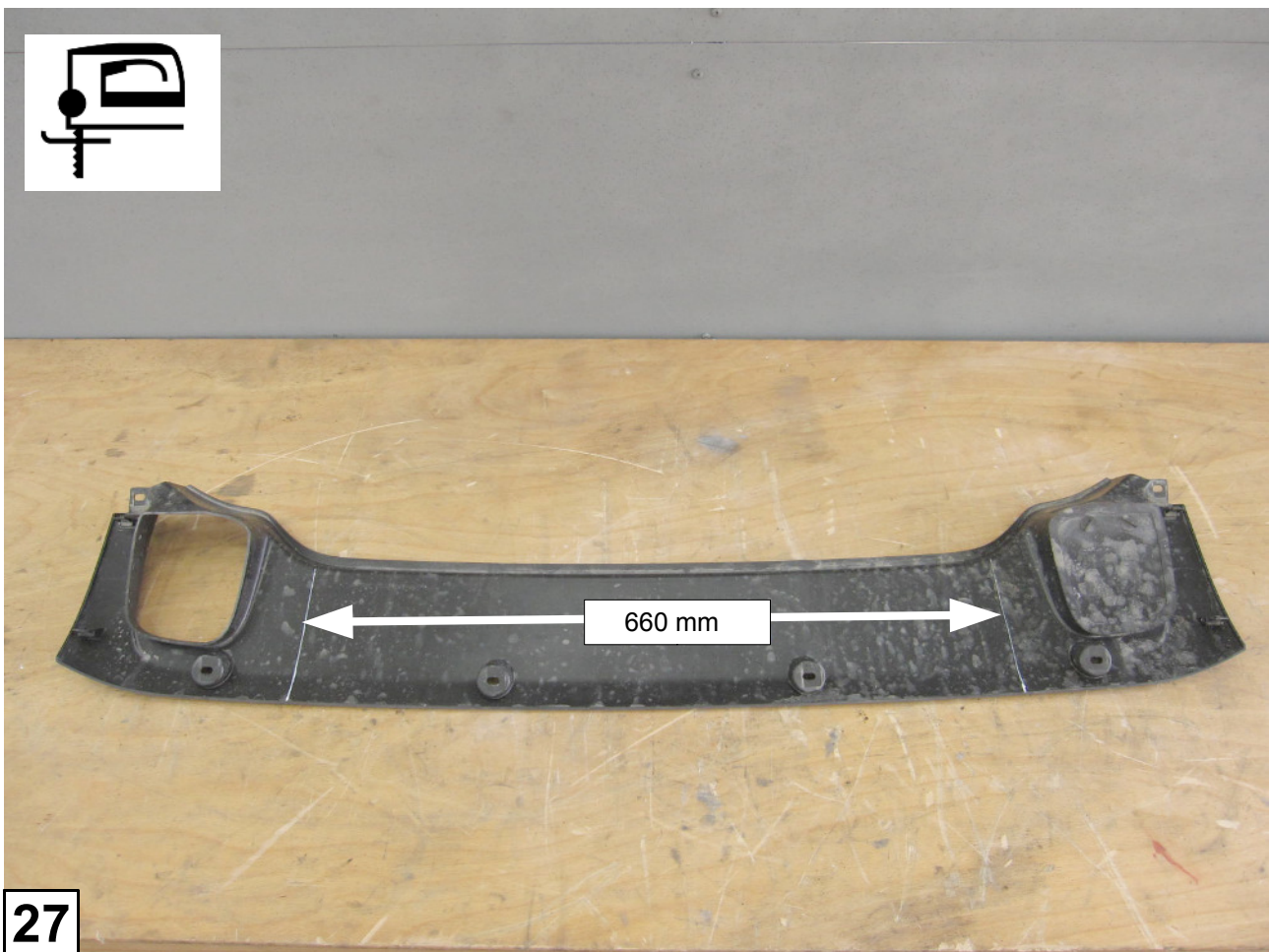
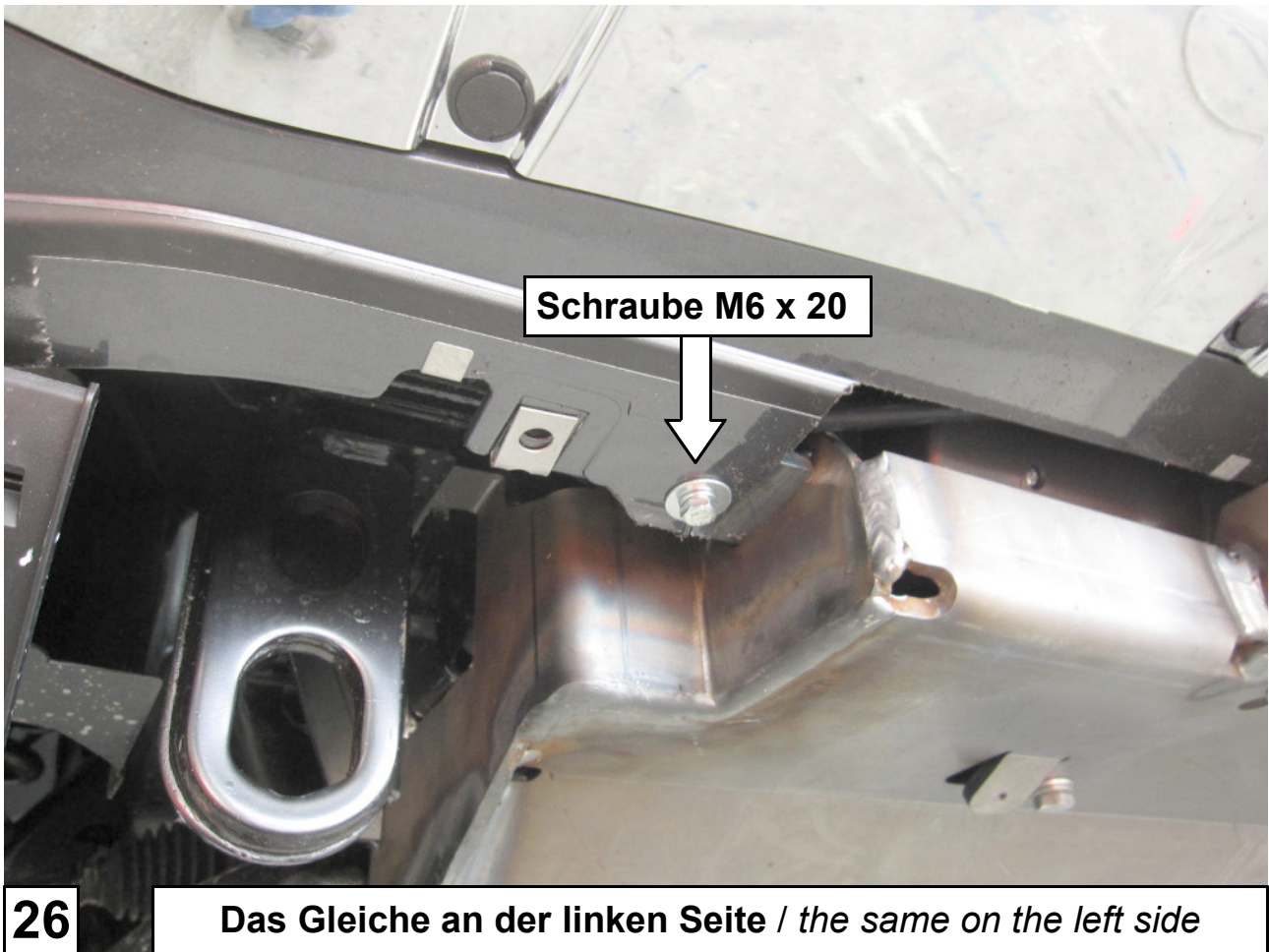

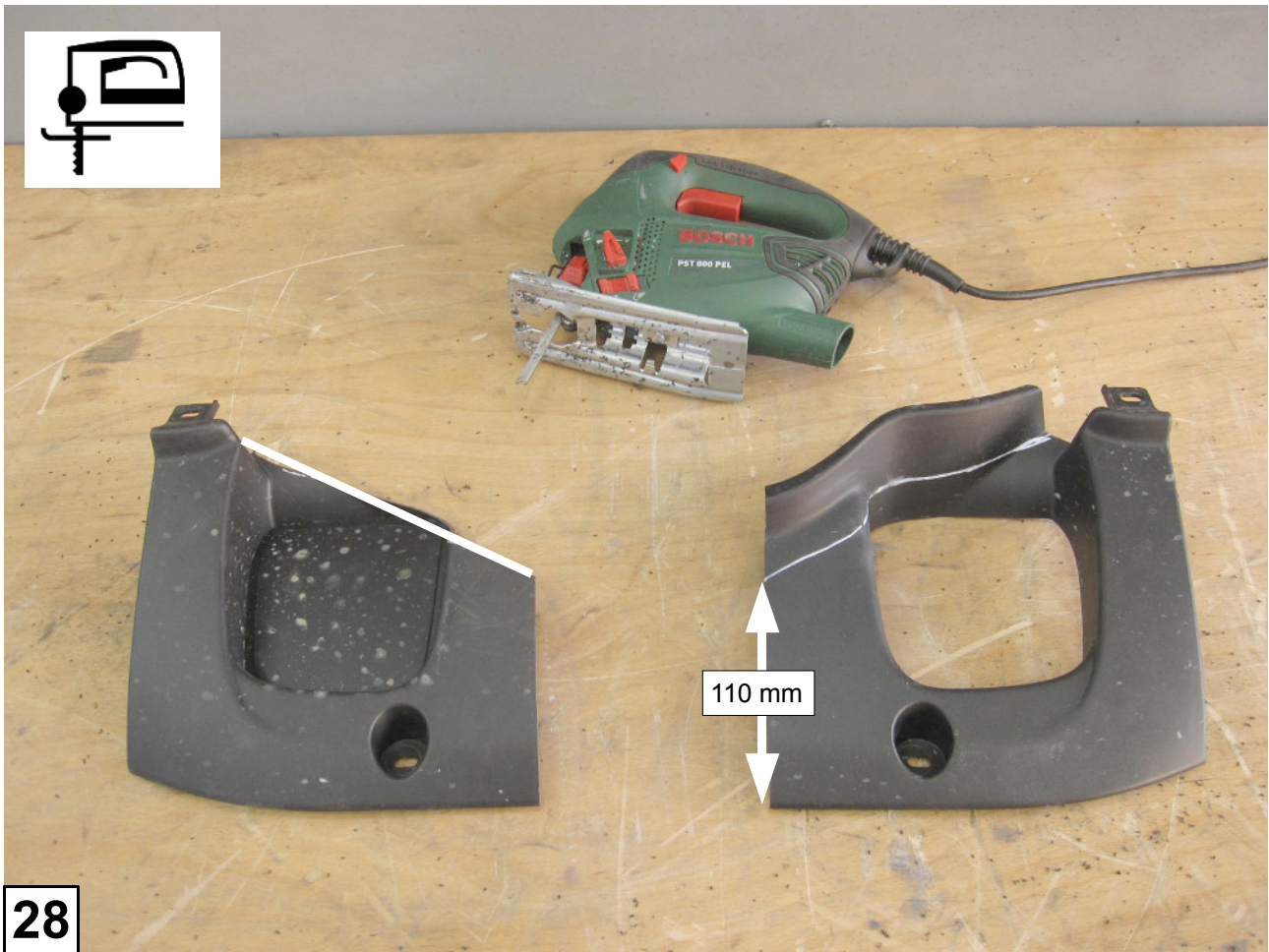

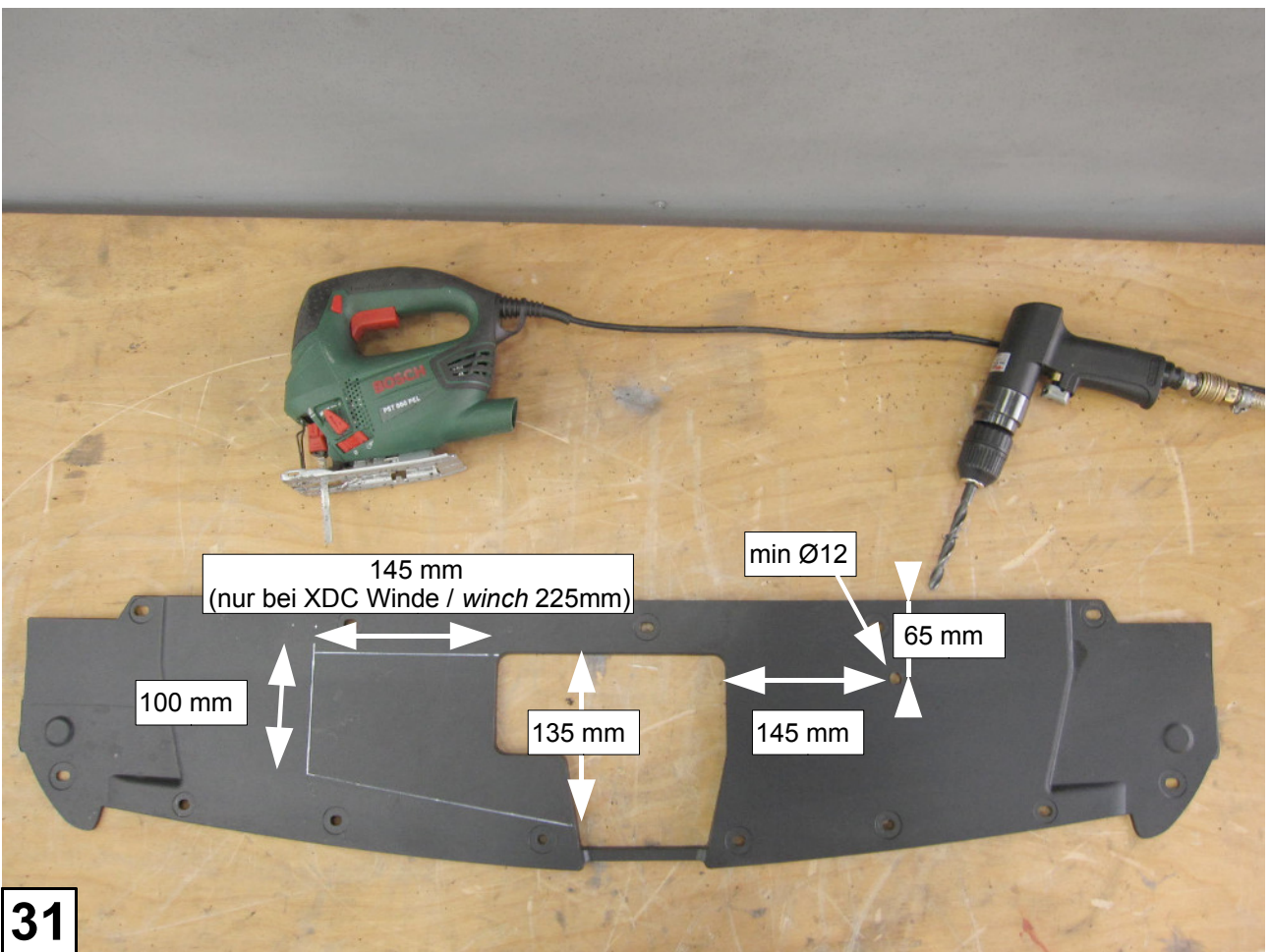

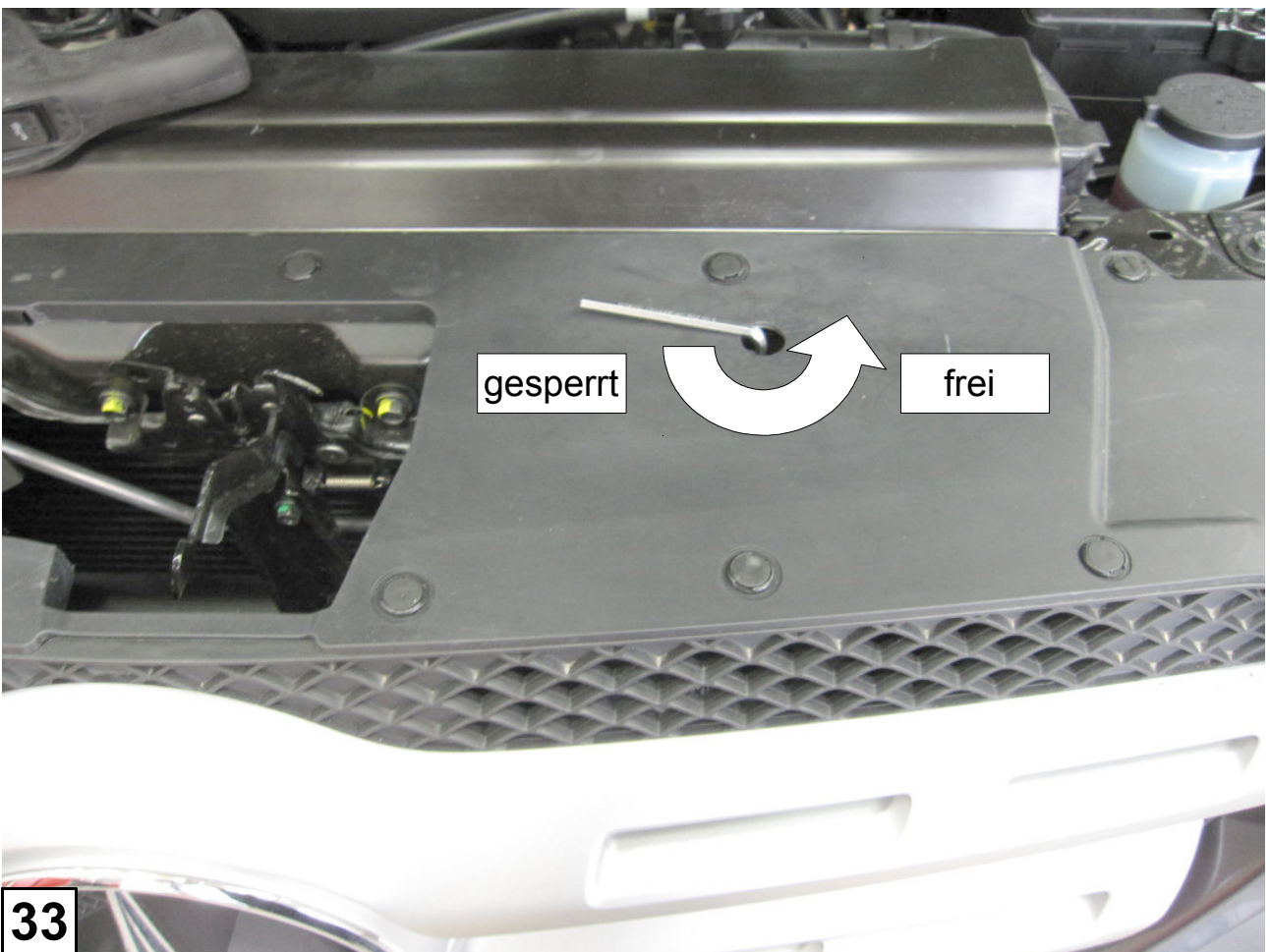
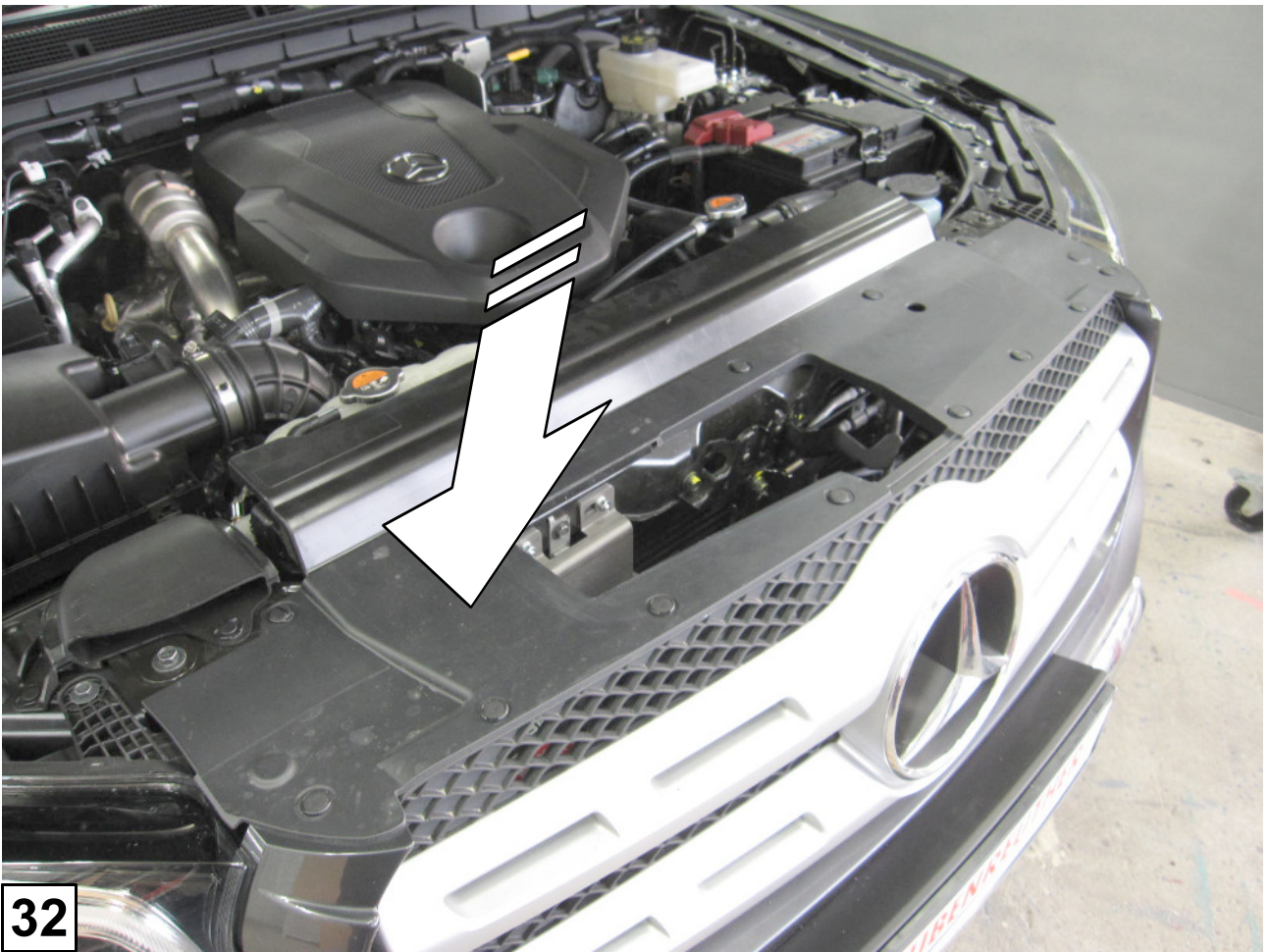

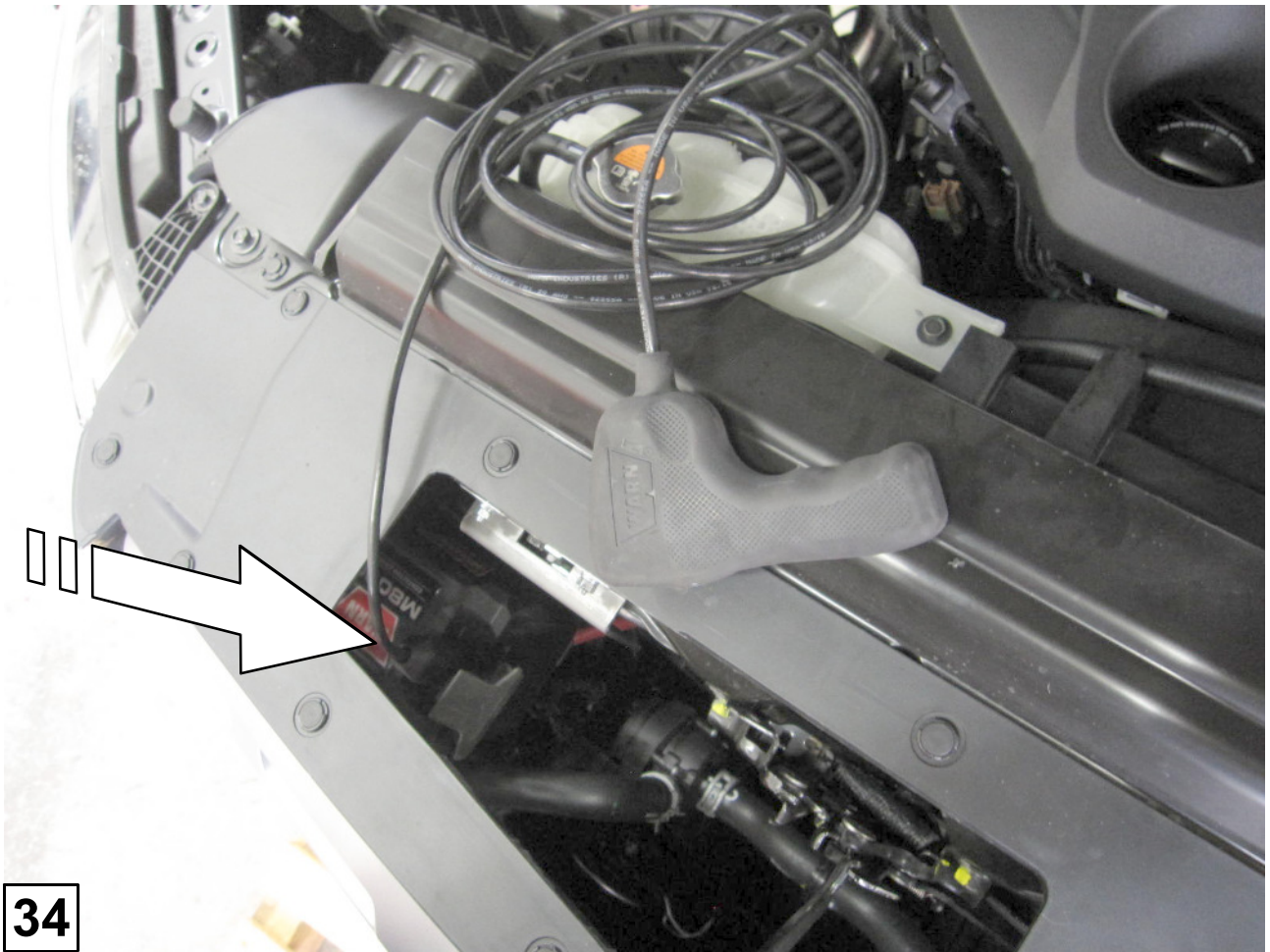

34



35

Schrauben Anzugsmomente	
Schraubengröße	Güteklasse - 8.8
M6	10 Nm
M8	25 Nm
M10	50 Nm
M12	87 Nm
M14	138 Nm
M16	210 Nm